

Model 3143B

BiConiLog™ Antenna

User Manual

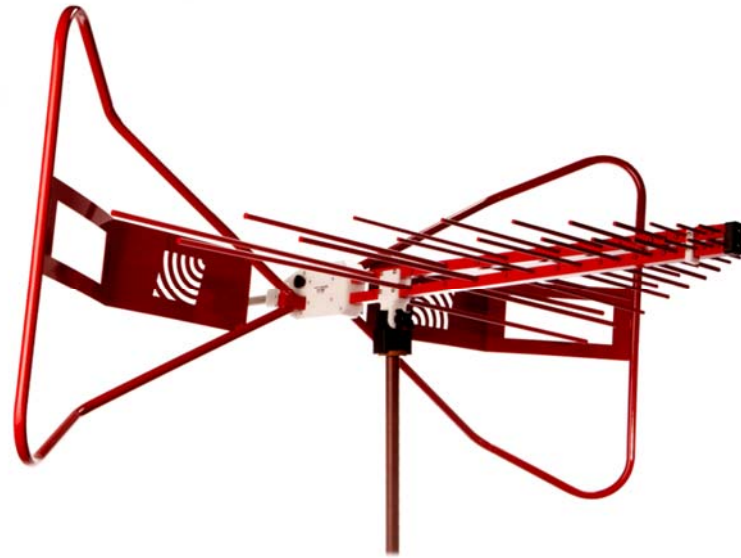

Model 3143B shown in horizontal polarization

ETS-Lindgren Inc. reserves the right to make changes to any product described herein in order to improve function, design, or for any other reason. Nothing contained herein shall constitute ETS-Lindgren Inc. assuming any liability whatsoever arising out of the application or use of any product or circuit described herein. ETS-Lindgren Inc. does not convey any license under its patent rights or the rights of others.

© Copyright 2012-2018 by ETS-Lindgren Inc. All Rights Reserved. No part of this document may be copied by any means without written permission from ETS-Lindgren L.P.

Trademarks used in this document: The *ETS-Lindgren* logo, *BiConiLog*, and *FACT* are trademarks of ETS-Lindgren Inc.

Revision Record | MANUAL,3143B | Part #399338, Rev. B

Revision	Description	Date
A	Initial Release	July, 2012
B	Added symmetry data	May, 2018

Table of Contents

Notes, Cautions, and Warnings	v
1.0 Introduction	7
Tripod Options	9
ETS-Lindgren Product Information Bulletin	10
2.0 Maintenance	11
Annual Calibration	11
Replacement and Optional Parts	11
Service Procedures	12
3.0 Specifications	13
Electrical Specifications	13
Physical Specifications	13
4.0 Assembly Instructions	15
Attach Bowtie Elements.....	16
5.0 Mounting Instructions	19
Using Included Mounting Adapters.....	20
Using the Stinger to Mount to a Model 2175 MiniMast.....	22
Additional Mounting Options.....	25
4-TR Mounting Options.....	25
7-TR and Mast Mounting Options.....	26
2x2 Boom Mounting Options	28
6.0 Typical Data	29
Typical Antenna Factor and Gain	29
Typical VSWR.....	30
Typical Beamwidth.....	31
Typical Power Requirements.....	32
Horizontal.....	32
Vertical.....	33
Symmetry.....	34
Appendix A: Warranty	37

This page intentionally left blank.

Notes, Cautions, and Warnings

	<p>Note: Denotes helpful information intended to provide tips for better use of the product.</p>
<p>CAUTION</p>	<p>Caution: Denotes a hazard. Failure to follow instructions could result in minor personal injury and/or property damage. Included text gives proper procedures.</p>
<p>WARNING</p>	<p>Warning: Denotes a hazard. Failure to follow instructions could result in SEVERE personal injury and/or property damage. Included text gives proper procedures.</p>



See the ETS-Lindgren *Product Information Bulletin* for safety, regulatory, and other product marking information.

This page intentionally left blank.

1.0 Introduction

The ETS-Lindgren **Model 3143B BiConiLog™ Antenna** is designed as a dual-purpose antenna that can be used for both immunity and emission testing. From 26 MHz to 6 GHz, the Model 3143B exhibits an average 5.5 dB gain improvement. Applications for the Model 3143B include emissions testing, immunity measurements, and medical equipment testing.

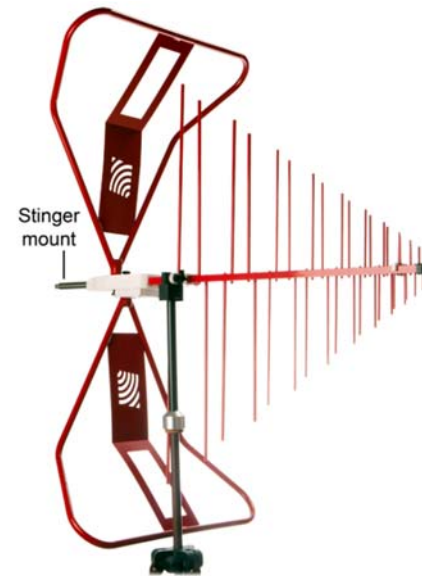

Model 3143B shown in vertical polarization

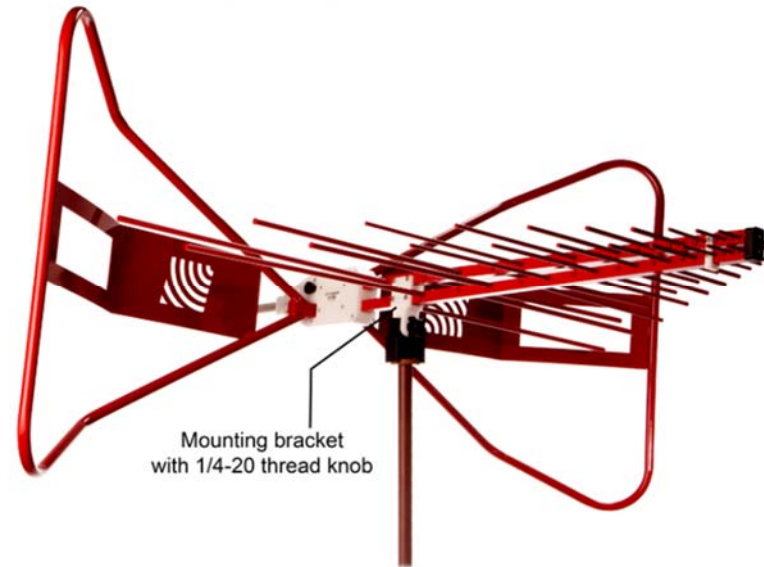

Model 3143B shown in horizontal polarization

The Model 3143B includes a stinger mount; it also includes a mounting bracket and 1/4–20 thread knob to attach to an ETS-Lindgren tripod or tower adapter. For the variety of mounting options available for the Model 3143B, see *Mounting Instructions* on page 19.

Tripod Options

ETS-Lindgren offers the following non-metallic, non-reflective tripods for use at both indoor and outdoor EMC test sites.



For easy horizontal and vertical polarization, the ETS-Lindgren Model 7-TR tripod is recommended.

- **4-TR Tripod**—Constructed of linen phenolic and delrin, designed with an adjustable center post for precise height adjustments. Maximum height is 2.0 m (80.0 in), and minimum height is 94 cm (37.0 in). This tripod can support up to an 11.8 kg (26.0 lb) load.



- **7-TR Tripod**—Constructed of PVC and fiberglass components, providing increased stability for physically large antennas. The unique design allows for quick assembly, disassembly, and convenient storage. Allows several different configurations, including options for manual or pneumatic polarization. Quick height adjustment and locking wheels provide ease of use during testing. Maximum height is 2.17 m (85.8 in), with a minimum height of 0.8 m (31.8 in). This tripod can support a 13.5 kg (30 lb) load.



ETS-Lindgren Product Information Bulletin

See the ETS-Lindgren *Product Information Bulletin* included with your shipment for the following:

- Warranty information
- Safety, regulatory, and other product marking information
- Steps to receive your shipment
- Steps to return a component for service
- ETS-Lindgren calibration service
- ETS-Lindgren contact information

2.0 Maintenance

CAUTION

Before performing any maintenance, follow the safety information in the ETS-Lindgren *Product Information Bulletin* included with your shipment.



Maintenance of the Model 3143B is limited to external components such as cables or connectors.

If you have any questions concerning maintenance, contact ETS-Lindgren Customer Service.

Annual Calibration

See the *Product Information Bulletin* included with your shipment for information on ETS-Lindgren calibration services.

Replacement and Optional Parts



ETS-Lindgren may substitute a similar part or new part number with the same functionality for another part/part number. Contact ETS-Lindgren for questions about part numbers and ordering parts.

Following are the part numbers for ordering replacement or optional parts for the Model 3143B.

Part Description	Part Number
Polarizing Mounting Adapter	100989
Thread Insert	105861



For additional/optional mounting hardware, see *Additional Mounting Options* on page 25.

Service Procedures

For the steps to return a system or system component to ETS-Lindgren for service, see the *Product Information Bulletin* included with your shipment.

3.0 Specifications

Electrical Specifications

Frequency Range:	26 MHz–1 GHz
Input Impedance (Nominal):	50 Ω
VSWR (Average):	2:1 above 80 MHz
Maximum Continuous Power	
30 MHz—60 MHz:	500 W
60 MHz—600 MHz:	1 kW
600 MHz—1000 MHz:	500 W
Peak Power:	1.3 kW
Pattern Type:	Directional
Polarization:	Linear
Connector:	Type N female

Physical Specifications

Height (Overall):	76.2 cm (30 in)
Length:	124.35 cm (48.96 in)
Width:	133.75 cm cm (52.66 in)
Weight:	5.5 kg (12 lb)

This page intentionally left blank.

4.0 Assembly Instructions

CAUTION

Before connecting any components, follow the safety information in the ETS-Lindgren *Product Information Bulletin* included with your shipment.

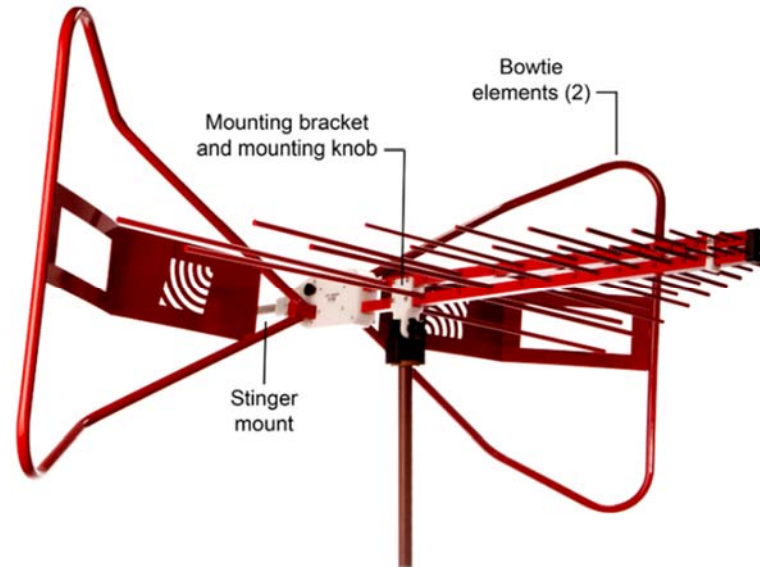

The Model 3143B BiConiLog™ Antenna consists of the following:

- Antenna
- Bowtie elements (2)
- 10–32 thumbscrew knobs to attach bowtie elements (2)
- Mounting bracket and mounting knob

Attach Bowtie Elements



Photos of bowtie elements used in this section may differ from the bowtie elements for your Model 3143B; the assembly procedure is the same for both.

The Model 3143B ships with the bowtie elements detached. To attach the bowtie elements:

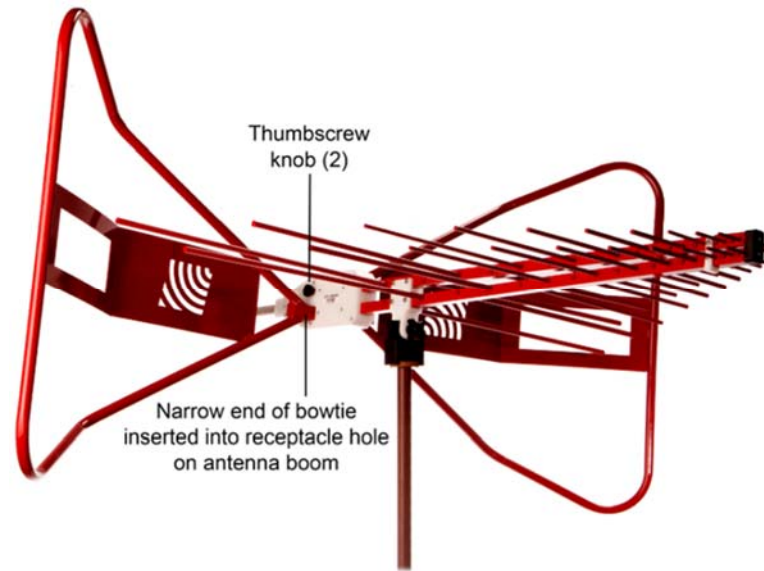

1. For stability, mount the Model 3143B onto a tripod or tower. See *Mounting Instructions* on page 19 for the steps to mount the antenna.

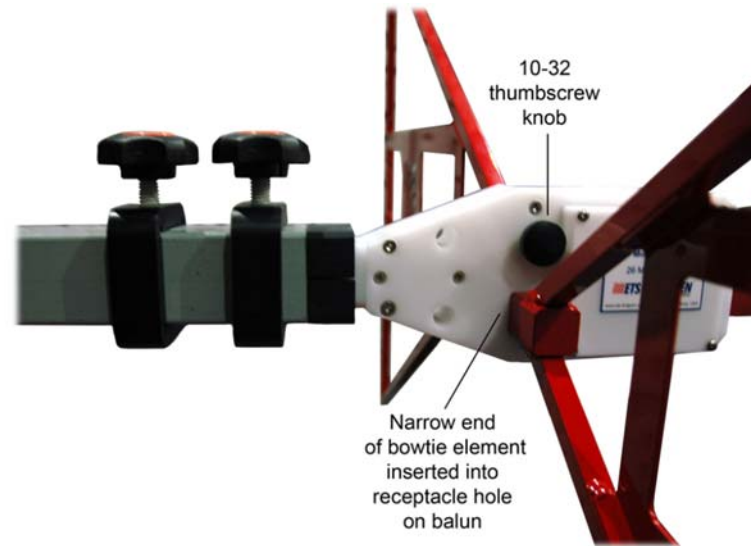

2. Slide the narrow end of one of the bowtie elements into the receptacle hole on the antenna balun, and then align the bowtie with the receptacle on the balun.

CAUTION

Do not cross thread this connection or permanent damage to the bowtie element could occur.

3. Insert one of the 10–32 thumbscrew knobs into the opposite side of the balun from where you inserted the bowtie. Slowly tighten the knob, taking care not to cross thread the connection.
4. Repeat steps 2 and 3 for the second bowtie element.

This page intentionally left blank.

5.0 Mounting Instructions

CAUTION

Before connecting any components, follow the safety information in the ETS-Lindgren *Product Information Bulletin* included with your shipment.

CAUTION

The Model 3143B antenna is a precision measurement device. Handle with care.

Contact with any metal or non-metallic structure can capacitively load the antenna, which may cause unrepeatable results. Therefore, make sure that no part of the dipole elements or bowties is in contact with the tripod or tower, particularly in vertically-polarized tests. Where possible, run the feed cable straight one meter or more back from the Model 3143B BiConiLog™ Antenna before dropping vertically.

Using Included Mounting Adapters

In addition to the attached mounting bracket and mounting knobs, the Model 3143B ships with these mounting adapters:

- **100989 Polarizing Mounting Adapter with 7/8–14 thread receptacle**

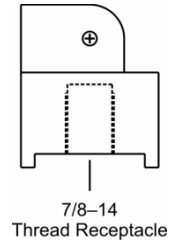

If you need to convert the polarizing adapter to a 1/4–20 receptacle, insert the 1/4–20 thread insert into the polarizing adapter



- **105861 1/4–20 Thread Insert**



To attach the included adapters to the Model 3143B:

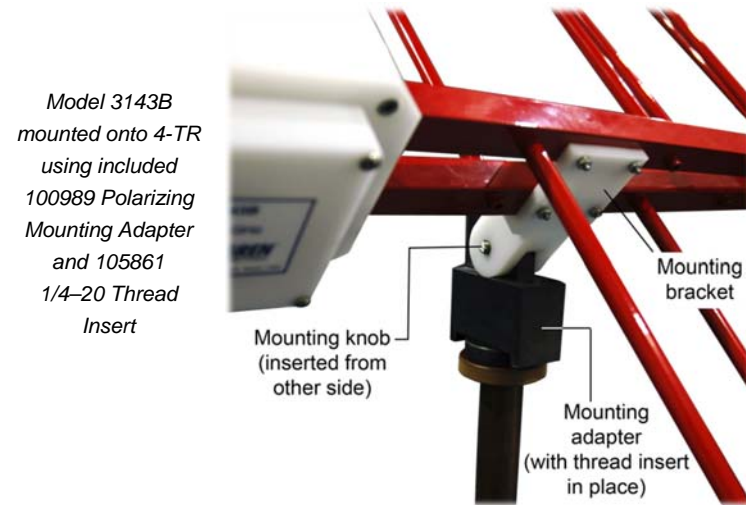

1. If required, insert the 1/4-20 thread insert into the mounting adapter.
2. Remove the mounting knob from the mounting bracket on the antenna.
3. Slide the mounting bracket onto the mounting adapter with the adapter placed between the shoulders of the mounting bracket.
4. Thread the mounting knob through the mounting bracket, then through the mounting adapter, and finally through the hex nut.
5. Tighten the mounting knob to secure the antenna.



Do not cross thread or permanent damage to the adapter and thread insert could occur.

6. Attach the mounting adapter and antenna to tripod or tower, as required.

Using the Stinger to Mount to a Model 2175 MiniMast



Do not use the stinger to mount the Model 3143B onto a 4-TR tripod.

The stinger mount provides on-axis rotation during 90° horizontal or vertical polarization. The stinger enables you to mount the antenna directly to an ETS-Lindgren 7-TR Tripod or mast.



Before you begin:

- Install the center rotate boom (part# 108197) for rear-mount stinger-type antennas.
- Attach the included mounting adapter to the Model 3143B as instructed in *Using Included Mounting Adapters* on page 20.
- You will need one of the optional mounting knobs described in *7-TR and Mast Mounting Options* on page 26. To order optional mounting hardware, contact the ETS-Lindgren Sales Department

1. Thread the antenna feed or receiving cable through the center of the boom so that the antenna connector emerges a few inches out of the clamp end of the boom.



2. Attach the cable to the Type N connector at the end of the stinger.

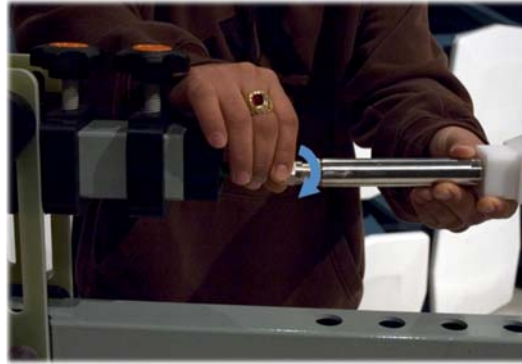

3. Slide the cable and stinger into the clamp on the boom, carefully guiding the cable out the other end.

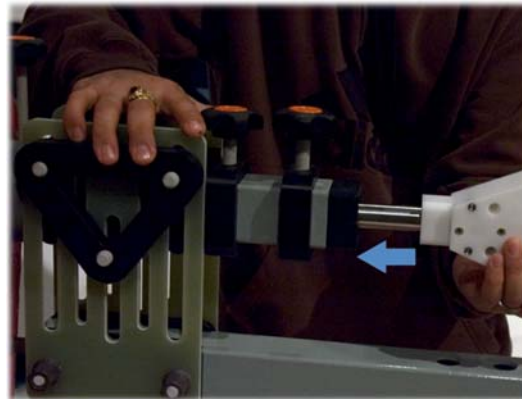

4. When you reach the back of the balun box, align it with the boom receptacle, and then slide the smaller portion of the balun box into the boom. This will prevent rotation of the antenna unless the boom is being polarized.

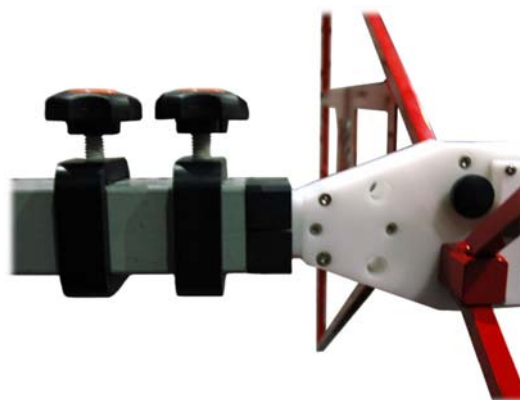

5. Tighten the clamp knobs on the boom to secure the antenna into place.



Additional Mounting Options

4-TR MOUNTING OPTIONS

Following are additional options for mounting the Model 3143B onto an ETS-Lindgren 4-TR tripod. Contact the ETS-Lindgren Sales Department for information on ordering optional mounting hardware.

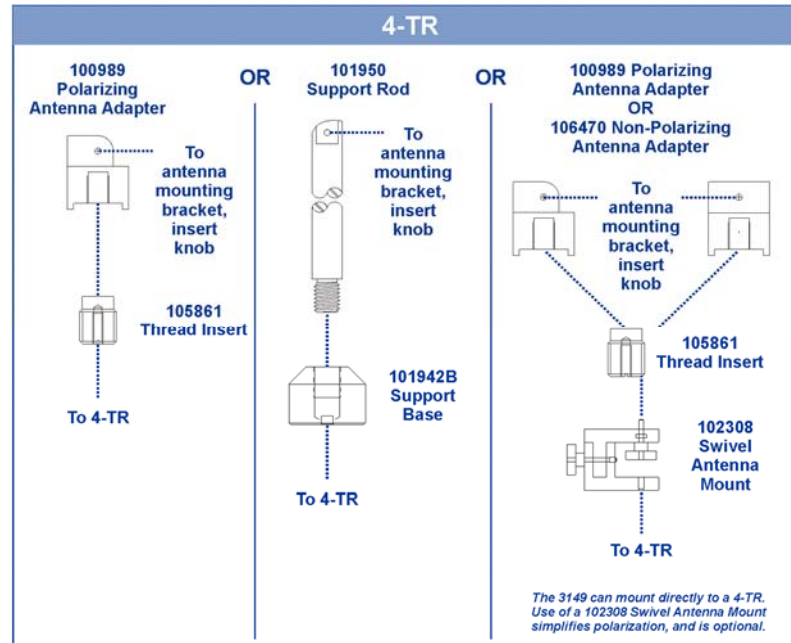

7-TR AND MAST MOUNTING OPTIONS

The stinger on the Model 3143B enables you to mount to antenna directly to an ETS-Lindgren 7-TR Tripod Positioner.

However, following are additional options for mounting the Model 3143B onto an ETS-Lindgren 7-TR Tripod Positioner.

Contact the ETS-Lindgren Sales Department for information on ordering optional mounting hardware.

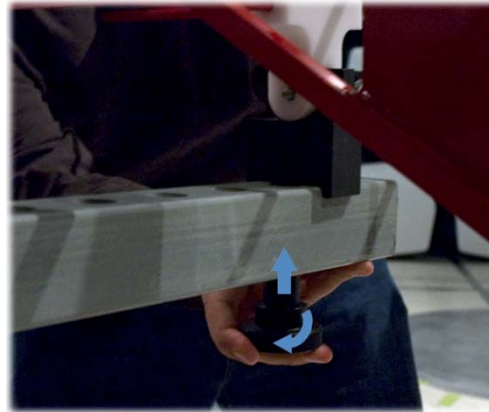

Non-stinger method to mount Model 3143B to 7-TR



Mast refers to 2070 Series, 2075, and 2175 Antenna Towers.
7-TR refers to 109042, 108983, and 108197 booms:

- 109042 boom—Straight boom; for general antenna mounting on a 7-TR
- 108983 boom—Offset boom; for general antenna mounting on a 7-TR with pneumatic or manual polarization; can also be used to mount stinger-type antennas
- 108197 boom—Center rotate boom; for stinger-type antennas only

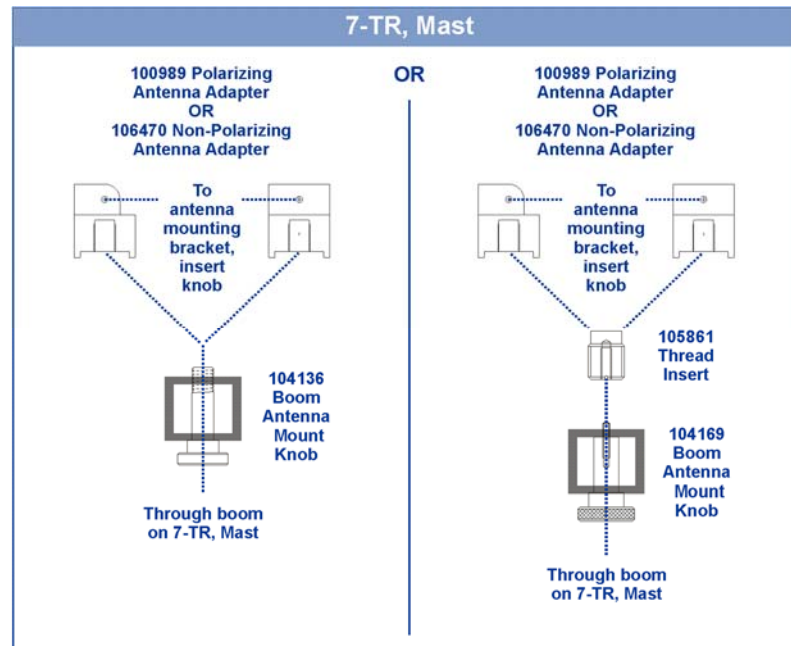

2x2 BOOM MOUNTING OPTIONS

Following are additional options for mounting the Model 3143B onto a 2x2 boom. Contact the ETS-Lindgren Sales Department for information on ordering optional mounting hardware.



2x2 boom refers to a typical 2-inch by 2-inch boom.

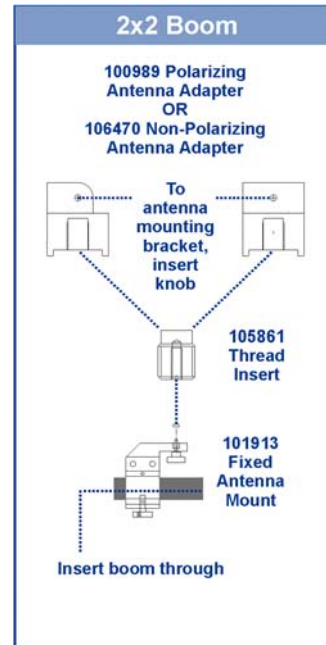

6.0 Typical Data

Typical Antenna Factor and Gain

Distance for the ANSI 3-meter and 10-meter calibrations is measured from the antenna midpoint, and for SAE 1-meter calibrations the distance is measured from the antenna tip. Midpoint is defined as half the distance between the small elements and the bowties, which is about 45 cm from the small end tip.

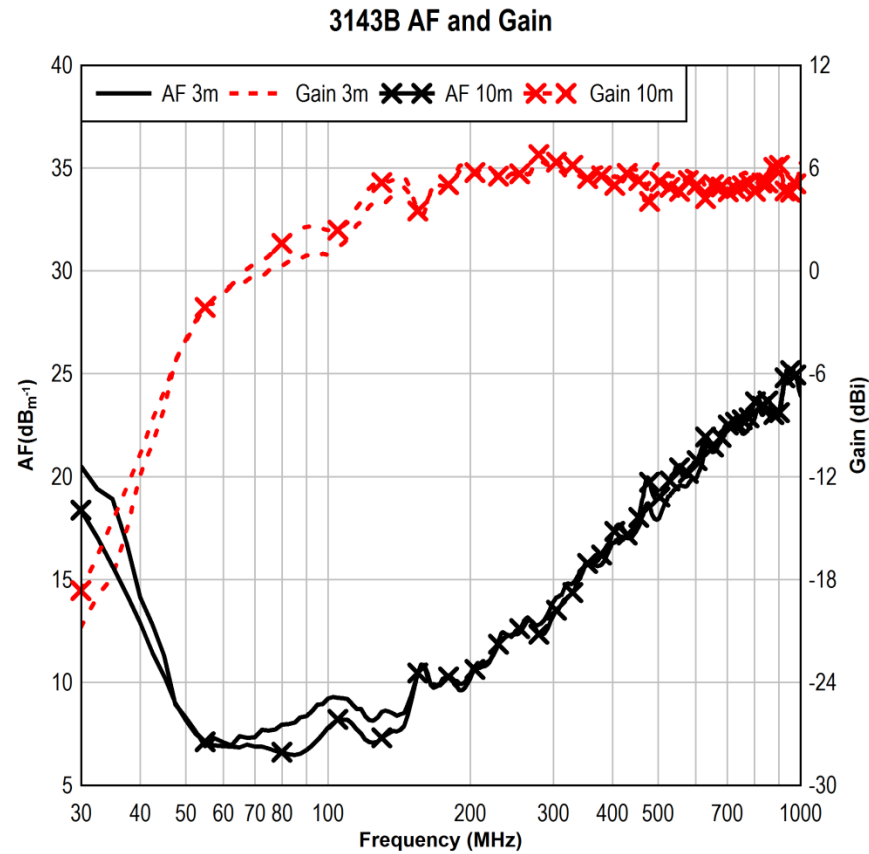

Typical VSWR

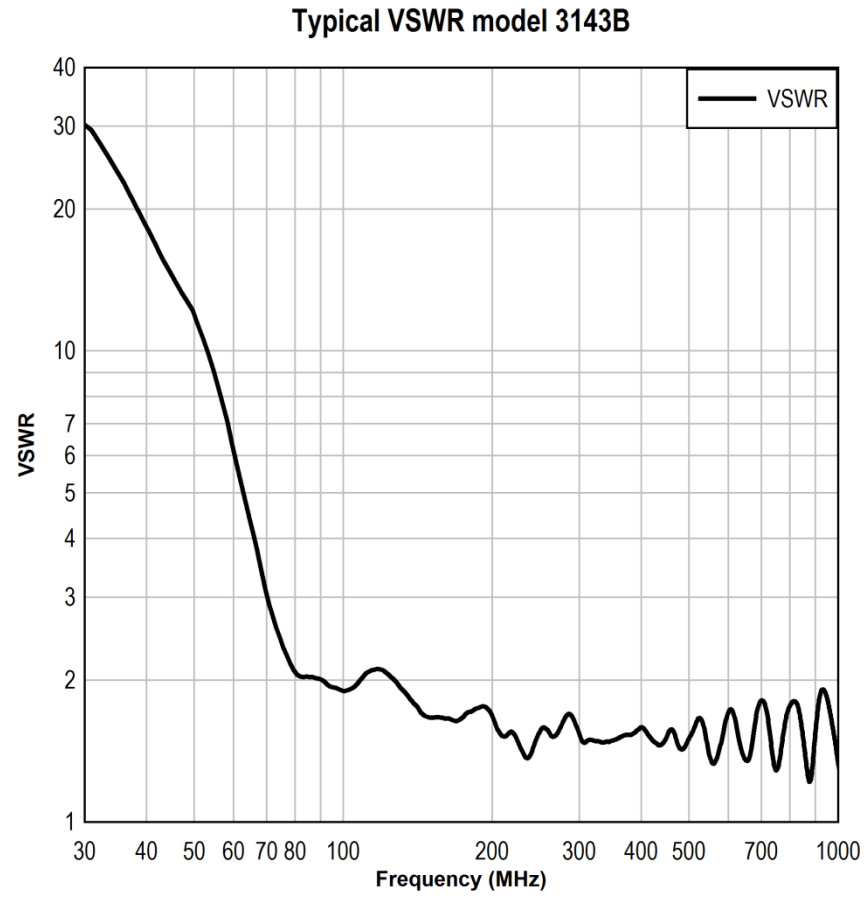

Typical Beamwidth

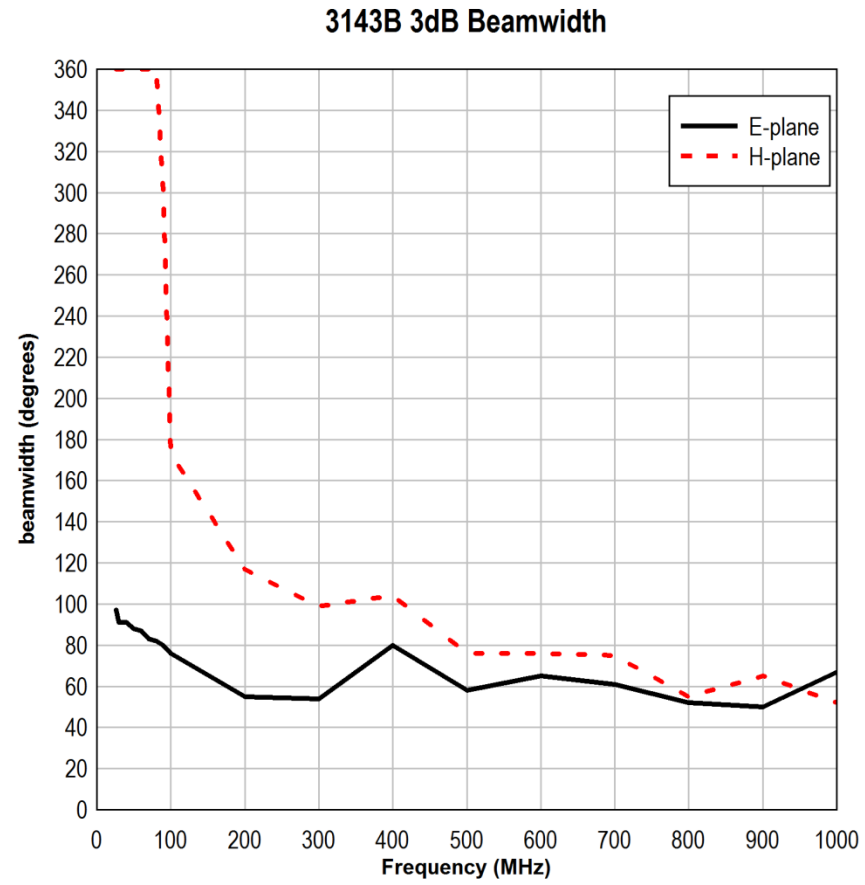

Typical Power Requirements

HORIZONTAL

3143B Power Required Horizontal at 3 m Distance
Average of power for 16 points on a 1.5m by 1.5 grid

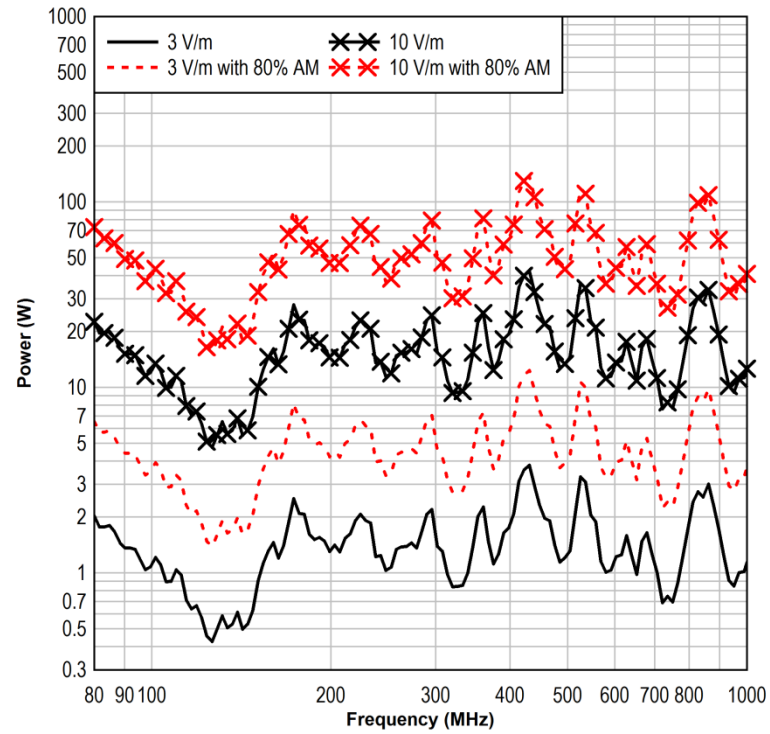

VERTICAL

3143B power requirements in FACT™ 3 chamber with ferrite floor

Vertical Polarization, Scaled from Measured Data
average of the power required for each of the 16 points on the grid

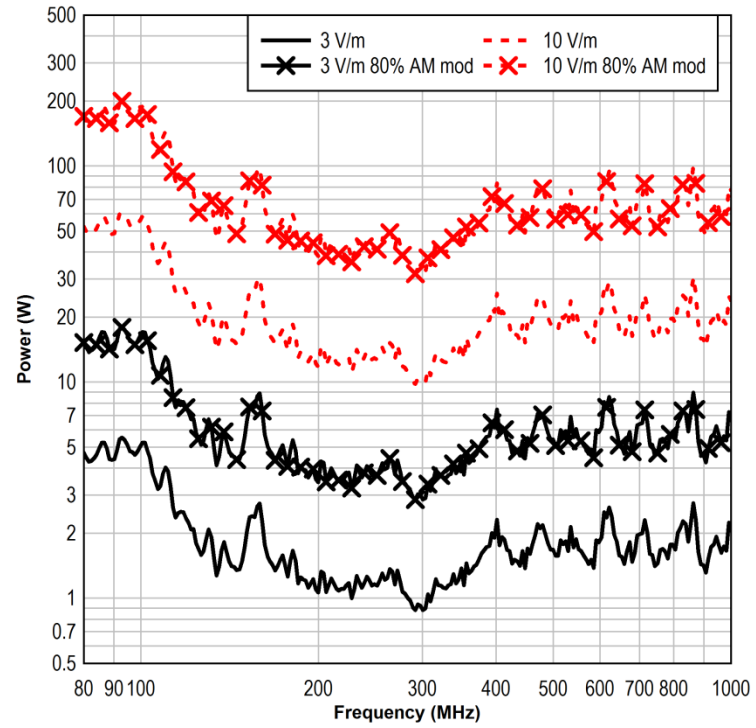

SYMMETRY

3143B Symmetry

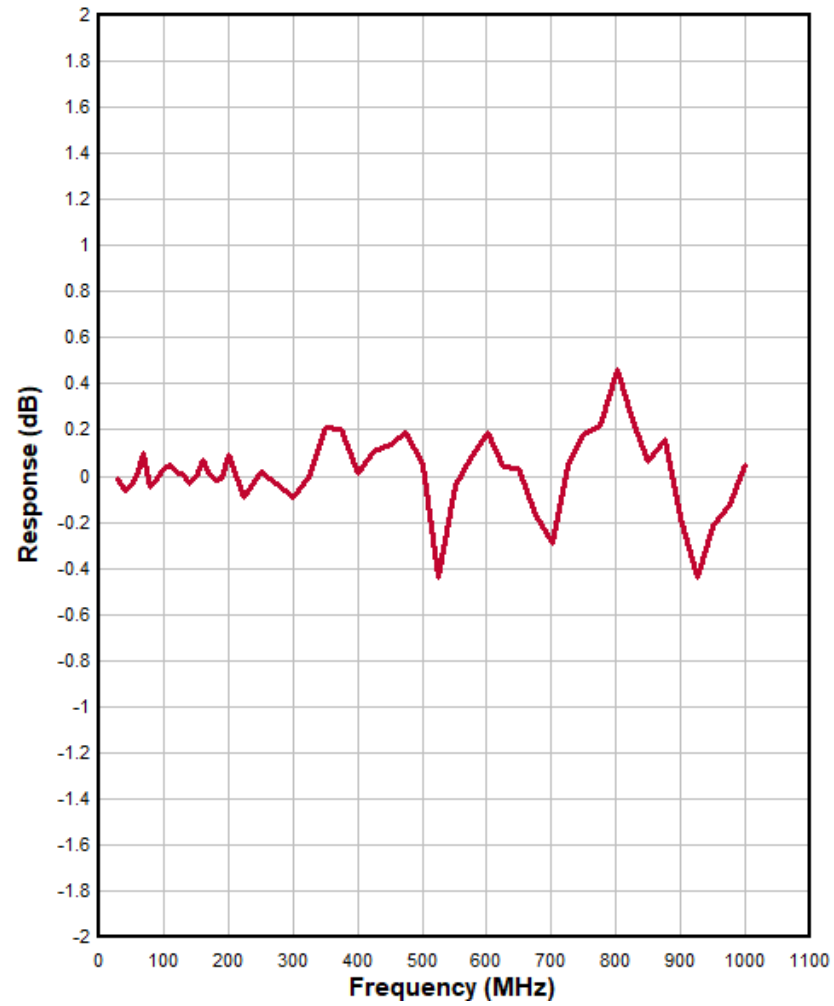

Frequency (MHz)	Symmetry (dB)
30	-0.01
40	-0.06
50	-0.04
60	0.02
70	0.1
80	-0.05
90	-0.01
100	0.03
110	0.05
120	0.01
130	0.01
140	-0.03
150	0
160	0.07
170	0.02
180	-0.02
190	-0.01
200	0.09
250	0.02
300	-0.09
350	0.21
400	0.01
450	0.14
500	0.05
550	-0.04
600	0.19

Frequency (MHz)	Symmetry (dB)
650	0.03
700	-0.29
750	0.18
800	0.46
850	0.06
900	-0.18
950	-0.22
1000	0.05

Appendix A: Warranty



See the *Product Information Bulletin* included with your shipment for the complete ETS-Lindgren warranty for your Model 3143B BiConiLog™ Antenna.

DURATION OF WARRANTIES FOR MODEL 3143B

All product warranties, except the warranty of title, and all remedies for warranty failures are limited to two years.

Product Warranted	Duration of Warranty Period
Model 3143B BiConiLog Antenna	2 Years



Accelonix BV ■ Luchthavenweg 18-b ■ NL-5657 EB Eindhoven
www.accelonix.nl ■ info@accelonix.nl ■ Tel.+31-40-7501650