

## EMSense 10/40 Laser Powered Electric Field Probe

With EMSense 10/40 Plug-In Card for EMCenter

Product Manual



## Copyright and Trademark

---

ETS-Lindgren Inc. reserves the right to make changes to any products herein to improve functioning or design. Although the information in this document has been carefully reviewed and is believed to be reliable, ETS-Lindgren does not assume any liability arising out of the application or use of any product or circuit described herein; nor does it convey any license under its patent rights nor the rights of others. All trademarks are the property of their respective owners.

© Copyright 2020–2024 by ETS-Lindgren Inc. All Rights Reserved. No part of this document may be copied by any means without written permission from ETS-Lindgren Inc.

Trademarks used in this document: The ETS-Lindgren logo is a registered trademark, and EMCenter, EMSense 10/ 40, ProbeView V, and TILE! are trademarks of ETS-Lindgren Inc.

## Revision Record

---

### MANUAL, EMSENSE 10/40 | Part #1720585, Rev. E

Revision	Description	Date
A	Initial Release	AUG, 2020
B	Revised Isotropic Response	OCT, 2021
C	EMSense 40 information added	FEB, 2023
D	Corrected EMSense 40 resolution spec	MAY, 2023
E	Update	FEB, 2024

## Safety Information

---



**High Voltage:** Indicates presence of hazardous voltage. Unsafe practice could result in severe personal injury or death.



**Protective Earth Ground (Safety Ground):** Indicates protective earth terminal. You should provide uninterruptible safety earth ground from the main power source to the product input wiring terminals, power cord, or supplied power cord set.



**Laser Warning:** Denotes a laser (class 1M) is part of the operating system of the device.

**NEVER** look into any of the fiber optic connectors. The LASER emits a beam that is invisible to the naked eye. Such light may cause permanent eye damage. Avoid eye or skin exposure to direct or scattered radiation.



**Waste Electrical and Electronic Equipment (WEEE) Directive:** (European Union) At end of useful life, this product should be deposited at an appropriate waste disposal facility for recycling and disposal. Do not dispose of with household waste.

## General Safety Considerations

---



Before power is applied to this instrument, ground it properly through the protective conductor of the AC power cable to a power source provided with the protective earth contact. Any interruption of the protective (grounding) conductor, inside or outside the instrument, or disconnection of the protective earth terminal could result in personal injury.



Servicing (or modifying) the unit by yourself may void your warranty. If you attempt to service the unit by yourself, disconnect all electrical power before starting. There are voltages at many points in the instrument which could, if contacted, cause personal injury.



Only trained service personnel should perform adjustments and/or service procedures upon this instrument. Capacitors inside this instrument may still be CHARGED even when instrument is disconnected from its power source.

## Notes, Cautions, and Warnings

---



**Note:** Denotes helpful information intended to provide tips for better use of the product.



**CAUTION:** Denotes a hazard. Failure to follow instructions could result in minor personal injury and/or property damage. Included text gives proper procedures.



**WARNING:** Denotes a hazard. Failure to follow instructions could result in **SEVERE** personal injury and/or property damage. Included text gives proper procedures.

# Table of Contents

---

Copyright and Trademark .....	2
Revision Record .....	2
Safety Information.....	3
General Safety Considerations .....	3
Notes, Cautions, and Warnings .....	4
<b>Table of Contents .....</b>	<b>5</b>
<b>Introduction .....</b>	<b>7</b>
Product Characteristics.....	8
Related Products.....	9
ETS-Lindgren Product Information Bulletin .....	9
EMSense 10 Field Probe and Kits.....	10
EMSense 40 Field Probe and Kits.....	12
EMSense 10/40 Individual Parts.....	14
Fiber Optic Cables .....	15
Processor Requirement.....	16
EMSense 10 Typical Performance Data.....	32
Typical Probe Isotropic Response at 400 MHz.....	32
Typical Probe Isotropic Response at 1000 MHz.....	33
Typical Probe Isotropic Response at 3000 MHz.....	33
Typical Probe Isotropic Response at 6000 MHz.....	34
<b>Operation .....</b>	<b>17</b>
Installation .....	17
Changing Plug-In Cards.....	17
Probe Stand.....	19
Laser Safety.....	20
Safety Precautions .....	21
Safety Features .....	21
Activate LASER Code .....	22
Manual Control .....	26
Back Panel.....	26
Touchscreen .....	27
Remote Control .....	34
Software Configuration for EMCenter 1-slot .....	35
<b>Maintenance .....</b>	<b>37</b>
Fiber Optic Maintenance .....	38

Handling Guidelines .....	38
Fiber Conditions .....	39
Service Procedures.....	39
Contacting ETS-Lindgren .....	39
Replacement and Optional Parts .....	39
Sending a Component for Service.....	40
Calibration Services and Annual Calibration .....	40
Upgrade Policies .....	40
<b>Specifications .....</b>	<b>41</b>
<b>EMSense 10 Probe Specifications .....</b>	<b>41</b>
Electrical (EMSense 10) .....	41
Physical (EMSense 10).....	42
Optical (EMSense 10).....	42
Safety (EMSense 10) .....	42
Calibration (EMSense 10) .....	43
<b>EMSense 40 Probe Specifications .....</b>	<b>43</b>
Electrical (EMSense 40) .....	43
Physical (EMSense 40).....	44
Optical (EMSense 40).....	44
Safety (EMSense 40) .....	44
Calibration (EMSense 40) .....	45
<b>Appendix A: EC Declaration on Conformity .....</b>	<b>46</b>

## Introduction

---

The EMSense 10 electric field sensor is the most accurate ultra-wideband sensor designed for electric field strength measurements. The sensor is small and fully optically isolated to minimize field perturbation.



*EMSense 10 card*



*EMSense 10 probe*



*EMSense 40 probe*

Applications for the E-field sensor are:

- Radiated immunity field monitoring
- Anechoic chambers calibration
- Field homogeneity measurements
- RF broadcast and welding radiation-hazard monitoring
- Long term field monitoring

## Product Characteristics

---

- **LASER Powered** – The sensor is LASER powered without the need for batteries. This allows 24/7 continuous testing at maximum performance without the need to change or recharge batteries.
- **Superb Measurement Accuracy** – To perform accurate field measurements, the E-field sensor dimensions must be as small as possible compared to the wavelength of the measured signal. There are two reasons for this:
  - First, because large sensor dimensions cause the sensor to resonate at lower frequencies and therefore causes measurement inaccuracies.
  - Secondly, to maintain field uniformity in an anechoic chamber. The smaller the sensor, the better the obtainable resolution for field homogeneity measurements.
- **Compact Sensor Dimensions**
  - In TEM and G-TEM cells, sensor dimensions above 10 cm are large compared to the dimensions of the homogenate field area.
  - The sensor dimensions of the EMSense 10 are extremely small, increasing measurement accuracy. In addition, the EMSense 10 is equipped with 2 antennas per axis (6 in total) to optimize isotropic performance and achieve best overall accuracy.
- **User Correction - Calibration factors** – Additionally, the EMSense 10 field sensor has capabilities to store “user correction factors” inside the field sensor. By applying calibration factors in the sensor itself, there is no risk one forgets to apply the frequency correction data when performing manual or automated tests.
  - The frequency of the measured field must be sent to the probe in order to apply the correct, frequency dependent, user calibration factor.
  - The frequency response correction factors which are determined during ISO17025 accredited calibration of the probe can be stored inside the field sensor.
  - When the user correction data is stored inside the probe the EMSense 10 field sensor will return corrected E-field readings without the need of additional calculations. Corrections will be applied inside the probe for each individual axis.
  - If a calibration is performed at ETS-Lindgren Calibrations, the correction factors will be loaded into the EMSense 10 field sensor by default by ETS-Lindgren.



## Related Products

---

- **EMCenter System (2-Slot and 7-Slot)**

- The EMCenter is a modular EMC test system that serves as the user and computer interface for all the EMCenter plug-in cards and modules, such as the EMSense 10/40 field sensors. EMCenter units are available in 2-slot and 7-slot versions. See [Processor Requirements](#) for more information.



- **EMCenter 1 Unit**

- The EMCenter 1 is a 1-slot unit that can be used to control the EMSense 10/40 from a computer.

- **ProbeView V Software**

- ProbeView V is a simple software package available for download at [ETS-Lindgren.com](http://ETS-Lindgren.com). ProbeView V provides real-time display, logging, and analysis of probe data as a support tool for EMF measurements.



- **TILE! - Totally Integrated Laboratory Environment System**

- EMSense 10 and EMSense 40 are fully supported by TILE! software.

## ETS-Lindgren Product Information Bulletin

---

See the ETS-Lindgren *Product Information Bulletin* included with your shipment for the following:

- Safety, regulatory, and other product marking information
- Steps to receive your shipment
- Steps to return a component for service
- ETS-Lindgren calibration service
- ETS-Lindgren contact information

## EMSense 10 Field Probe and Kits

The EMSense 10 sensor can be purchased as a stand-alone item or as part of a kit.

### EMSense 10 Field Probe Kits for Use with 2-Slot or 7-Slot EMCenter



**Note:** Kits **1714963** and **1714964** do not include an EMCenter unit. The EMCenter 2-Slot or 7-Slot units are sold separately.





KIT 1714963 7007-201 10 M KIT, PROBE + CARD + 10 M FIBER CABLE		
<b>1710780</b>	<b>1702423</b>	<b>1702414</b>
7007-201 EMSense 10 Field Sensor (10 kHz - 10 GHz)	7007-200 EMSense 10/40 Plug-In Card	10 Meter Fiber Extension Cable FC/ST
*1702417 - Coupling Set FC/ST included		





KIT 1714964 7007-201 20 M KIT, PROBE + CARD + 20 M FIBER CABLE		
<b>1710780</b>	<b>1702423</b>	<b>1702415</b>
7007-201 EMSense 10 Field Sensor (10 kHz - 10 GHz)	7007-200 EMSense 10/40 Plug-In Card	20 Meter Fiber Extension Cable FC/ST
*1702417 - Coupling Set FC/ST included		

## EMSense 10 Field Probe Kits for Use with 1-Slot EMCenter



**Note:** Kits 1714959 and 1714961 include an EMCenter 1 unit for connection to a PC.

KIT 1714959 7007-201 10 M KIT, PROBE + CARD + EMCENTER 1 + 10 M FIBER CABLE			
			
<b>1710780</b>	<b>1702423</b>	<b>1703647</b>	<b>1702414</b>
7007-201 EMSense 10 Field Sensor (10 kHz - 10 GHz)	7007-200 EMSense 10/40 Plug-In Card	7000-012 EMCenter 1 RS232, USB	10 Meter Fiber Extension Cable FC/ST
*1702417 - Coupling Set FC/ST included			

KIT 1714961 7007-201 20 M KIT, PROBE + CARD + EMCENTER 1 + 20 M FIBER CABLE			
			
<b>1710780</b>	<b>1702423</b>	<b>1703647</b>	<b>1702415</b>
7007-201 EMSense 10 Field Sensor (10 kHz - 10 GHz)	7007-200 EMSense 10/40 Plug-In Card	7000-012 EMCenter 1 RS232, USB	20 Meter Fiber Extension Cable FC/ST
*1702417 - Coupling Set FC/ST included			



## EMSense 40 Field Probe and Kits



The EMSense 40 sensor can be purchased as a stand-alone item or as part of a kit.

### Field Probe Kits for Use with 2-Slot or 7-Slot EMCenter



**Note:** Kits **1741724** and **1741725** do not include an EMCenter unit. The EMCenter 2-Slot or 7-Slot units are sold separately.





KIT 1741724 7007-203 10 M KIT, PROBE + CARD + 10 M FIBER CABLE		
		
<b>1738260</b>	<b>1702423</b>	<b>1702414</b>
7007-203 EMSense 40 Field Sensor (10 kHz - 40 GHz)	7007-200 EMSense 10/40 Plug-In Card	10 Meter Fiber Extension Cable FC/ST





KIT 1741725 7007-203 20 M KIT, PROBE + CARD + 20 M FIBER CABLE		
		
<b>1738260</b>	<b>1702423</b>	<b>1702415</b>
7007-203 EMSense 40 Field Sensor (10 kHz - 40 GHz)	7007-200 EMSense 10/40 Plug-In Card	20 Meter Fiber Extension Cable FC/ST

## EMSense 40 Field Probe Kits for Use with 1-Slot EMCenter



**Note:** Kits 1741726 and 1741727 include an EMCenter 1 unit for connection to a PC.

KIT 1741726 7007-203 10 M KIT, PROBE + CARD + EMCENTER 1 + 10 M FIBER CABLE			
			
<b>1738260</b>	<b>1702423</b>	<b>1703647</b>	<b>1702414</b>
7007-203 EMSense 40 Field Sensor (10 kHz - 40 GHz)	7007-200 EMSense 10/40 Plug-In Card	7000-012 EMCenter 1 RS232, USB	10 Meter Fiber Extension Cable FC/ST

KIT 1741727 7007-203 20 M KIT, PROBE + CARD + EMCENTER 1 + 20 M FIBER CABLE			
			
<b>1738260</b>	<b>1702423</b>	<b>1703647</b>	<b>1702414</b>
7007-203 EMSense 40 Field Sensor (10 kHz - 40 GHz)	7007-200 EMSense 10/40 Plug-In Card	7000-012 EMCenter 1 RS232, USB	20 Meter Fiber Extension Cable FC/ST

## EMSense 10/40 Individual Parts

---



### EMSense 10 E-field sensor (with fixed fiber cables):

Electric field sensors to be used together with the plug-in card including small probe stand.

- Model: 7007-201
- Part Number: 1710780



### EMSense 40 E-field sensor (with fixed fiber cables):

Electric field sensors to be used together with the plug-in card including small probe stand.

- Model: 7007-203
- Part Number: 1738260



### EMSense 10 Plug-In Card:

An electric field sensor plug-in card to be used in the EMCenter or EMCenter 1 system.

- Model: 7007-200
- Part Number: 1712423

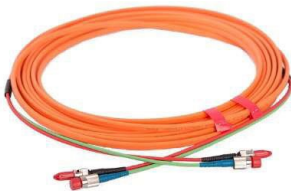

### Fiber Extension Cable:

Fiber extension cable with in-line couplings.

- 10 Meter Cable Part Number: 1702414
- 20 Meter Cable Part Number: 1702415
- Additional fiber lengths are available upon request.



### Coupling Set:

Coupling set consisting of an FC/FC and ST/ST coupling to connect the extension fiber cable to the sensor fiber cable.

- Part Number: 1702417

## **Fiber Optic Cables**

---

Use an extension fiber to connect the sensor to the plug-in card mounted in the EMCenter. This extension fiber is a duplex fiber cable and uses dissimilar connectors to avoid incorrect connections. The fiber optic cable with FC connectors feeds LASER light to the field sensor. The fiber optic cable with ST connectors is used for bi-directional data communication between the field sensor and the plug-in card.

Refer to maintenance section for fiber handling and conditions.

To ensure safe and correct operation of the sensor, only use the EMSense 10/40 with the original supplied or ordered fibers. Do not use other fibers than those supplied by ETS-Lindgren.

Fiber extension cables with different lengths up to 100 meters are available on request. Contact ETS-Lindgren for more detailed information.

## Processor Requirement



**Note:** The 2-slot and 7-slot EMCenter require an ARM processor board with firmware version 3.3.3 or higher to operate the EMSense 10/40 field probes and interface card. 2-slot and 7-slot EMCenter systems utilizing an X86 processor board and/or firmware version 3.3.0 or older are **not supported** and will not communicate with the EMSense interface card.

To view the 2-slot or 7-slot EMCenter version information, navigate to the main screen and press the Info button. Slot 8 indicates the processor version of this EMCenter as shown in the graphic below.

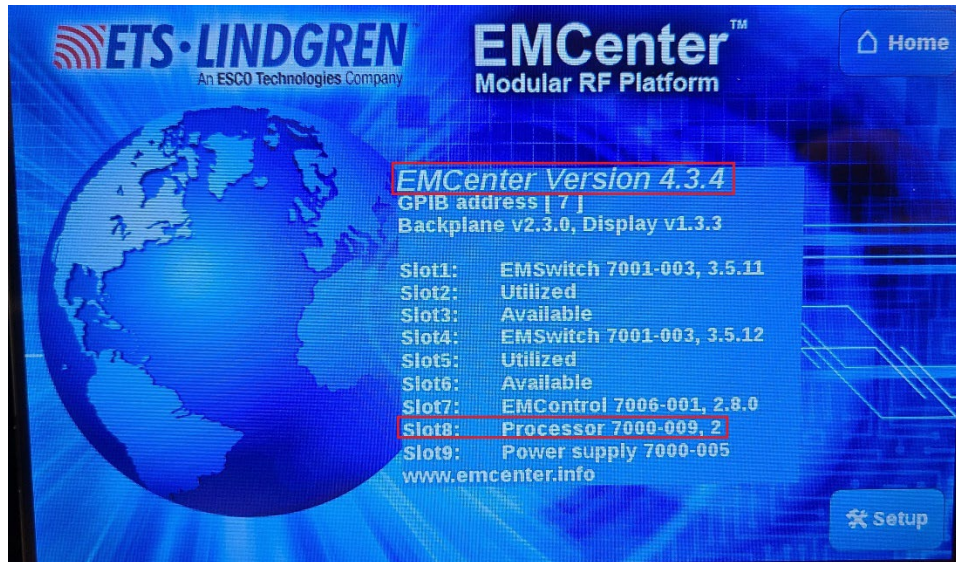

**Note:** If the EMCenter is not operating the 7000-008 or 7000-009 processor card, contact ETS-Lindgren to purchase a new 2-slot or 7-slot EMCenter or a new processor card compatible with EMSense.

Model Number	Part Number	Processor Type
7000-008	1611365	EMCENTER PROCESSOR BOARD STD (ARM)
7000-009	1695739	EMCENTER PROCESSOR BOARD + GPIB (ARM)



# Operation

---

## Installation

---



**CAUTION:** Before connecting any components, follow the safety information in the ETS-Lindgren *Product Information Bulletin* included with your shipment.



**WARNING:** Always unplug the unit before starting maintenance to prevent electrical shock. Maintenance includes removal of the plug-in cards or the top panel.



**CAUTION:** Leave an empty slot or space 1U in height beneath the EMCenter to allow sufficient cooling through the bottom air inlets of the cabinet.

## Changing Plug-In Cards

---

1. Before installing and inserting a new plug-in card make sure that the EMCenter is turned OFF and disconnect the AC Mains power cord.
2. Determine in which empty slot of the EMCenter you want to install the Plug-in Card. Looking at the back of the EMCenter, the slots are numbered 1 through 7 from left to right.



**Note:** Due to the width of some cards, two consecutive empty slots are required for installation. The card will use the track of the first of the two slots.

3. Remove the blank panel from the slot by removing the two screws at the top of the blank panel and the two screws at the bottom. Be careful not to lose the screws.
4. Carefully insert the card into the slot of the EMCenter. Position the plug-in card into the slot and slowly push it, using the lower part of the plug-in card. When it reached the end of the rail, gently push and lock the plug-in card into the backplane socket.
5. Secure the card by tightening the four previous screws using a Pozi type screwdriver head PZ1.

6. Plug the interlock into the connector on the back of the EMCenter.
7. Connect the plug-in card to the desired device(s).
  - Place the EMSense 10 E-field sensor where the field strength is to be measured.
  - Clean the ends of the fibers and connect the cables to both the sensor and the plug-in card. Make sure the latching pin (notch) of the FC and ST connector fits correctly in the slot of the chassis connector (in line coupling).

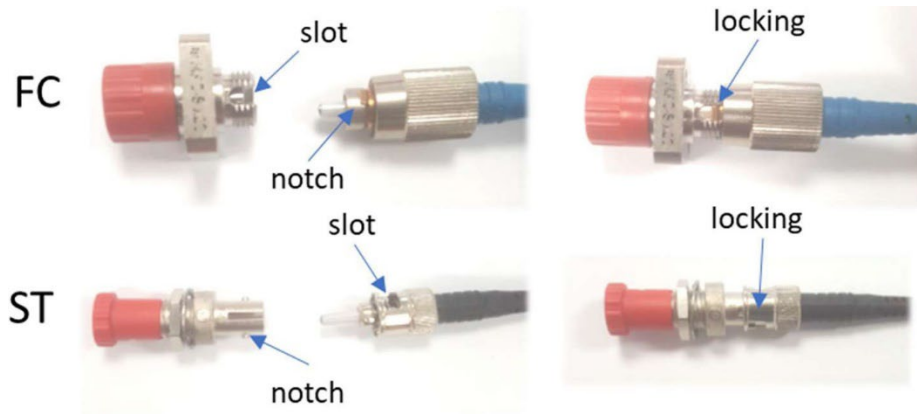

8. **Optional:** Connect the EMCenter to a computer using Ethernet or GPIB.
9. Re-connect the AC mains power cord and turn ON the EMCenter. It can now be started by tapping the touch screen. The EMCenter will automatically detect the newly installed card.
10. The card installation is complete and the EMCenter is now ready for use. You can control all cards through the [touchscreen](#) or sending [remote commands](#).

# Probe Stand

The EMSense 10 is supplied with a probe stand consisting of the following parts: a base, the feet (in three pcs), a pole, and an angle mount.

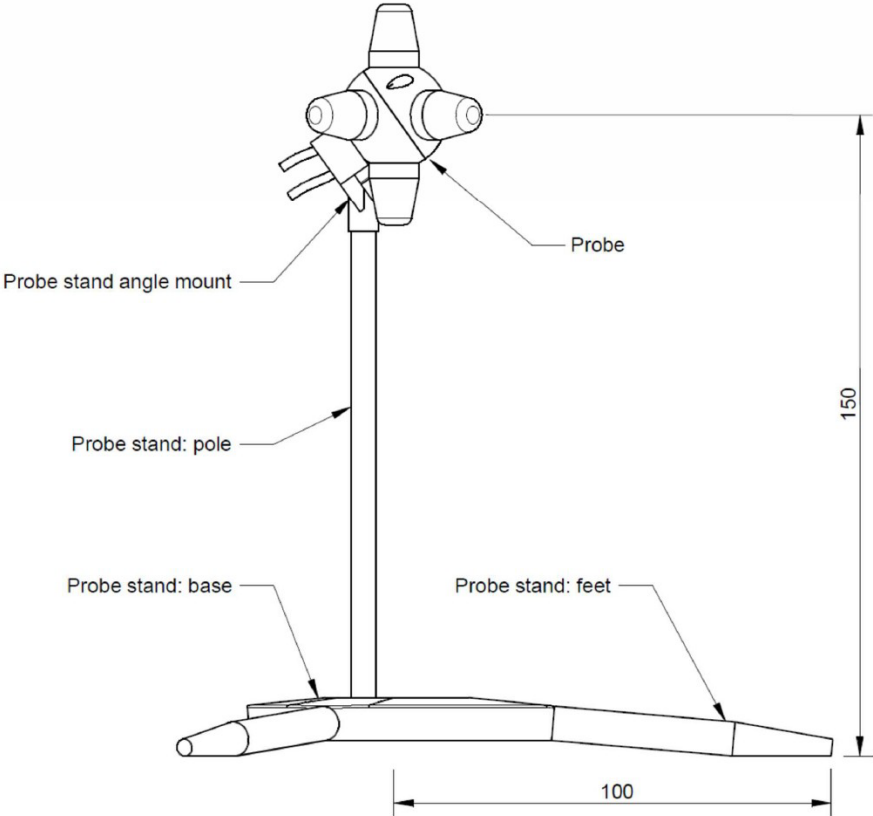

The probe stand parts can be easily assembled together. The 3 feet can be screwed into the side of the base. Screw the pole into the M4 internally threaded hole in the base top. Using this probe stand pole with feet, the probe is positioned at the desired height above the surface and can be easily positioned 100mm from a table edge.

The probe stand can also be used without the feet. The assembly can be mounted on a separate probe stand (not included) via the 1/4 - 20 UNC internal thread hole located in the center of the base.

The use of the mounting angle is optional. For isotropic measurements of an electrical field of which the polarization is unknown (for example in reverb chamber / mode-stir chambers) the mounting angle is not needed, see left picture.



For accurate measurements of electrical field with a known polarization, the mounting angle can be used to position one axis of the EMSense 10 parallel to the field. See right picture. In most situations, this is the way an E-field sensor is calibrated, axis by axis. Therefore, the probe should be used in the same way to obtain the most accurate results. Failure to perform these tasks may result in damage to the fiber optic connectors or cables.



**Note:** Placing any material in close proximity to the field sensor will influence the field and could cause measurement errors.

## Laser Safety



**CAUTION:** For additional safety information, see the ETS-Lindgren Product Information Bulletin included with your shipment.

**INVISIBLE LASER RADIATION - DO NOT  
EXPOSE USERS OF TELESCOPIC OPTICS  
Class 1M LASER product  
Max. 500 mW at 808 nm**

## Safety Precautions

---



### **LASER RADIATION AVOID EXPOSURE TO BEAM CLASS 3B LASER PRODUCT**

- **WAVELENGTH 808 nm**
- **OPTICAL POWER 0.5 W**



### **CAUTION: Never look into any of the fiber optic connectors.**

- **The laser emits an infrared beam that is invisible to the naked eye.**
- **Direct or even reflected light will cause permanent eye damage.**



### **INVISIBLE LASER RADIATION: Do not stare into beam or view directly with optical instruments.**

- **Avoid eye or skin exposure to direct or scattered radiation.**

Some EMCenter™ Modular RF Platform plug-in cards use a high power laser to supply energy to a remote (floating) measuring device. The wavelength of these lasers is approximately 808 nm. These lasers are high-power, infrared lasers and invisible to the human eye. Please read the documentation and safety instructions provided in the separate manual for the specific card.

Exposure to any laser radiation during normal operation is not likely because the EMCenter uses only fiber-coupled lasers. However, for the safety of all employees, please comply with the following rules:

- When the EMCenter is not in use, power off the unit.
- The remote interlock connection should be connected to an emergency master disconnect and in series with the room door or fixture interlocks.
- Connect all fiber cables and install protective covers before switching on the system. Protective covers are identified by the following label:

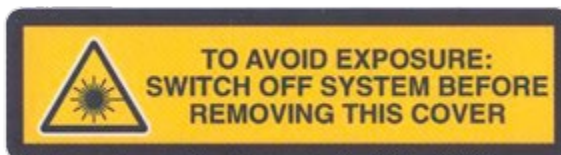

- Do not attempt to turn on the EMCenter if the fiber optic cables show any sign of damage.

## Safety Features

---

To make the EMCenter as safe as possible, the primary safety system of each plug-in card is designed to work standalone, without any intervention from the EMCenter. Apart from this, the EMCenter has its own safety interlock system, which is connected in series with the interlock system of every installed card.

Additionally, the following safety measures are implemented:

- The EMCenter is equipped with a remote interlock system. For example, this interlock system would prevent inadvertent laser radiation by preventing someone from entering a shielded room and stepping on a fiber.
- To prevent accidental activation of the laser, an Acknowledge button will appear directly after the Laser Start button is pressed. The laser will start only if this button is pressed within a four-second timeframe.
- A visual Laser On indicator warns the operator of laser activity. The Laser On LED on the front panel of EMCenter indicates that at least one laser is active.

## **Activate LASER Code**

---

### **Precaution for 1-slot EMCenter**

The EMCenter Single (1-slot) is often used in combination with the EMSense 10 electric field probe series. As an additional safety measure the EMCenter has a safety feature which needs to be triggered before the laser can be activated.

Since the Single Slot does not have a touch-screen it has a specific activation procedure combined with audible warnings is used.

#### **To activate the laser in the EMCenter Single (1-slot):**

1. Press the 'Start' button on the back panel of the EMCenter and hold it.
2. Five loud 'beep' sounds can be heard; four short beeps followed by one long beep.
3. On the fifth 'beep' the laser link is activated and the red 'laser ON' LED on the card lights up.
4. Release the 'Start' button.

#### **During LASER activation:**

- If the activation process is to be interrupted, release the 'Start' button (before the fifth 'beep'). The laser will not be activated.

- If the activation process is interrupted (and released 'Start' button by accident), the laser will not be activated.
- The user is warned by an audible warning when the start button is pressed by accident (i.e. without the intention to activate the laser).
- To prevent accidental activation of the laser, an auditory warning will alert you of the laser activation procedure (if the 'Start' button is being pressed).
- To interrupt the activation process, all you must do is release the 'Start' button.

## Precaution for 2-slot and 7-slot EMCenter

As a safety precaution, products that use a LASER can only be turned on using a LASER Code. This code can be entered into the system by use of the touchscreen of the EMCenter.

(This safety feature is linked to the EMCenter 2-slot and 7-slot version. The LASER activation and safety is implemented differently in the EMCenter 1.)

To meet the LASER safety precaution, enter the LASER Code in the 'LASER Code' screen and press 'OK' for confirmation.



The default LASER code is **3447**

This code can be changed by the customer in the main configuration screen.

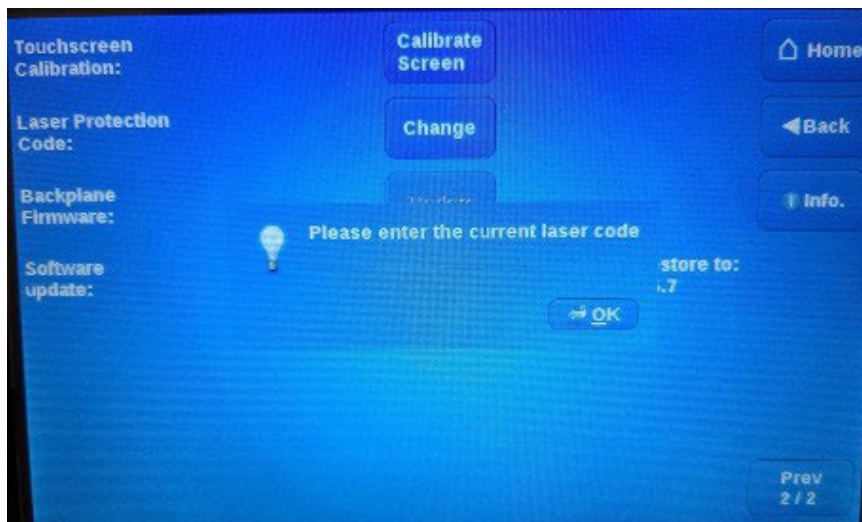



To change the laser code, the user will be asked to enter the current code once and the new code twice (for confirmation). Press 'Close' to leave each notification and enter the code in the following numeric window.

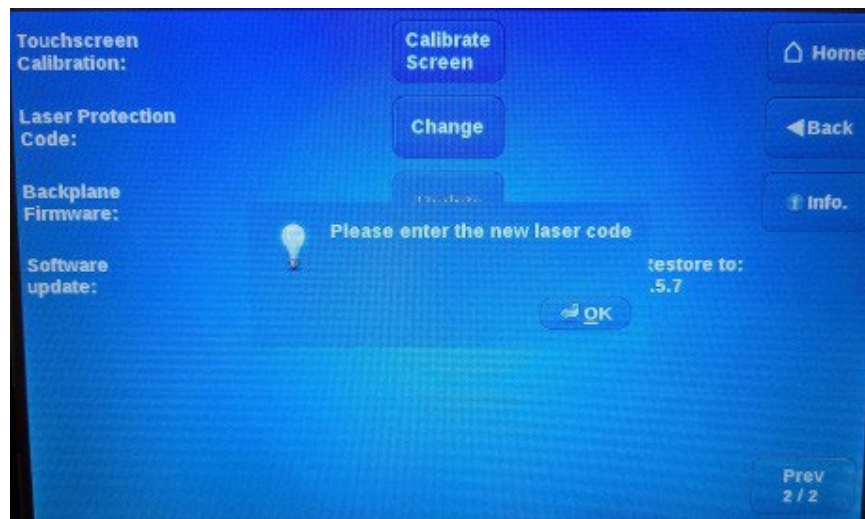

The probe stand parts can be easily assembled together. The 3 feet can be screwed into the side of the base. Screw the pole into the M4 internally threaded hole in the base top. Using this probe stand pole with feet, the probe is positioned at the desired height above the surface and can be easily positioned 100mm from a table edge.

The probe stand can also be used without the feet. The assembly can be mounted on a separate probe stand (not included) via the 1/4 - 20 UNC internal thread hole located in the center of the base.

The use of the mounting angle is optional. For isotropic measurements of an electrical field of which the polarization is unknown (for example in reverb chamber / mode-stir chambers) the mounting angle is not needed.

For accurate measurements of electrical field with a known polarization, the mounting angle can be used to position one axis of the EMSense 10 parallel to the field. In most situations, this is the way an E-field sensor is calibrated, axis by axis. Therefore, the probe should be used in the same way to obtain the most accurate results. Failure to perform these tasks may result in damage to the fiber optic connectors or cables.

Placing any material in close proximity to the field sensor will influence the field and could cause measurement errors.

## Manual Control

---

### Back Panel

---

The following connections and indicators are found at the back panel of the plug-in card:

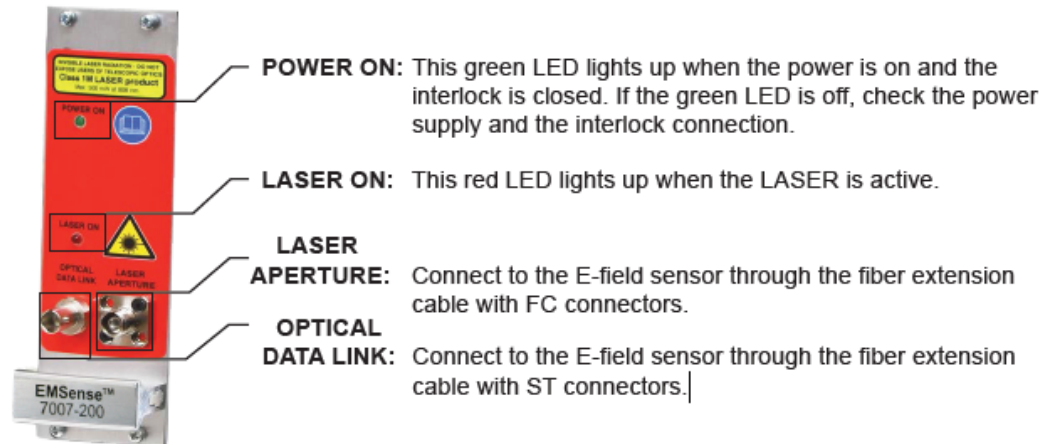

### Fiber Optic Cables

Use an extension fiber to connect the sensor to the plug-in card mounted in the EMCenter. This extension fiber is a duplex fiber cable and uses dissimilar connectors to avoid incorrect connections.

The fiber optic cable with FC connectors feeds LASER light to the field sensor. The fiber optic cable with ST connectors is used for bi-directional data communication between the field sensor and the plug-in card.

To ensure safe and correct operation of the sensor, only use the EMSense 10 with the original supplied or ordered fibers. Do not use other fibers than those supplied by ETS-Lindgren.

Fiber extension cables with different lengths up to 100 meters are available on request. Contact your local reseller for more detailed information.

## Touchscreen

---

### Home Screen

Readings from the probe can be taken directly from the 2-slot or 7-slot EMCenter screen. The status box tells you the Etot value in V/m.



The '**STATUS**' box in the main screen of the EMCenter only displays the total isotropic field strength. When more advanced data is required (such as field strength of the separate axis, probe temperature, LASER current etc.), navigate to the 'Instrument'-screen by pressing the '**STATUS**' box of the required device from the main screen.

## Starting the LASER Powered Sensor

The LASER of the EMSense 10 field sensor can be started from the 'main' window of the EMCenter. To activate the sensor, press the 'Start' button for the required sensor and, within 4 seconds, the 'ACK' button. A short sound will be audible until the safety loop is closed successfully.

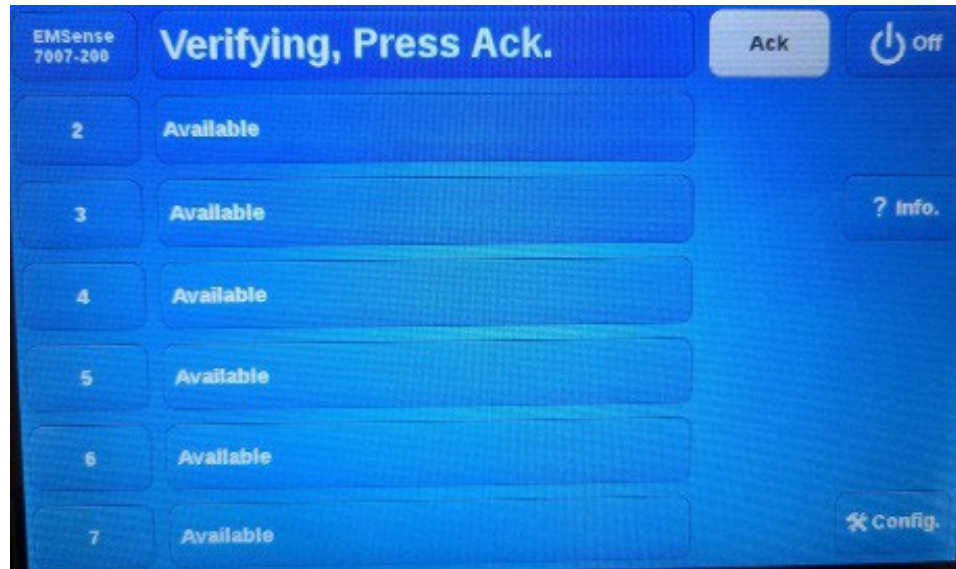

As long as the LASER is activated, the front and rear 'LASER ON'-LED's will light up to indicate LASER operation.

## Zeroing the Probe

The '**STATUS**' box will now indicate "**Press this button to zero**" and after pressing this button the zeroing of the probe will be started.



As soon as the probe is zeroed, the '**STATUS**' box will display the measured field strength of the probe.

The E-field sensor is now powered on and will return optical data to the EMCenter system. As long as the probe returns optical data, the LASER will continue to power the sensor. If the loop is interrupted, the LASER will switch off immediately.



**Note:** For maximum accuracy, it is recommended to re-zero the probe whenever the probe temperature changes by more than 5 degrees Celsius as determined by using the TC command.

## EMControl Instrument Screen

This page shows the Probe Configuration and Advanced Measurement Data of the EMSense 10 probe.

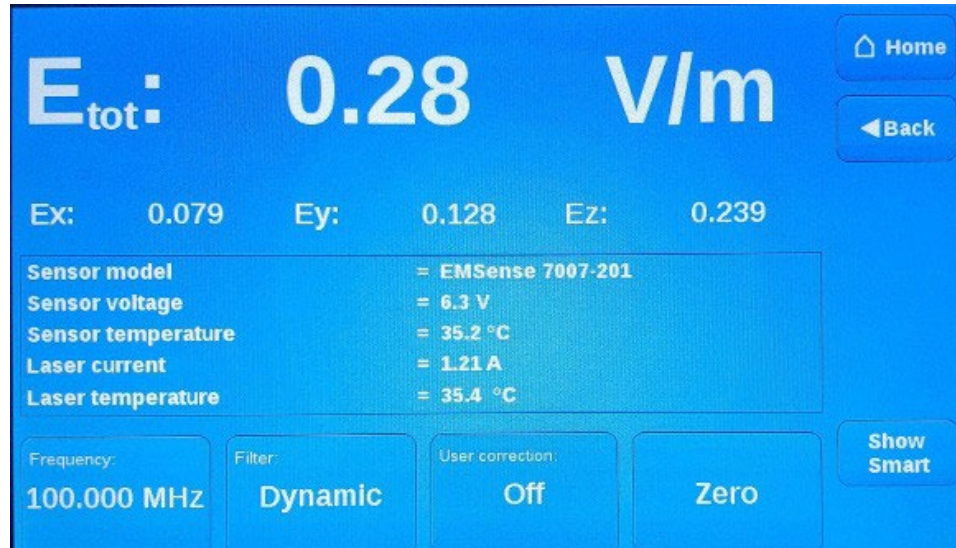

The “**Instrument**”-screen will display the field strength in a large font, together with the field strength data of each separate axis. In addition; probe information and LASER information are also displayed in the ‘Instrument’-screen.

- The **calculation** of the summed field strength, is done according to the following formula:

$$E_{tot} = \sqrt{E_x^2 + E_y^2 + E_z^2}$$

- With the ‘**Frequency**’ button the carrier frequency of the measured field strength can be defined.
- The ‘**Filter**’ button can be used to apply an averaging factor on the measurement reading. The available filter settings are:
  - DYN = dynamic (16 to 128 times depending on value) (this is the default setting)
    - 1 = 4 times average
    - 2 = 8 times average
    - 3 = 16 times average
    - 4 = 32 times average
    - 5 = 64 times average
    - 6 = 128 times average

- Pressing the 'Zero' button will arrange that the EMSense 10 sensor reading will be 'zero-ed'.



**Note:** Ensure the amplifier is turned off prior to zeroing the field probe.

## User Correction Data

Every new EMSense 10 probe is factory adjusted and verified. All required correction data is stored inside the field probe.

The EMSense 10 probe has the feature to store external calibration data as “user correction factors” inside the probe. This means that the correction data will be automatically applied to the measured field in run time at the specified frequency. Due to this, there is no longer a need to apply correction factors inside a measuring application.

The advantage of storing the calibration data inside the probe as “user correction factors”, is that the data is in one place and making it easier to maintain the correct calibration information. Apart from this, the corrections can be applied to each individual axis instead of using an average correction factor for the x-, y- and z-axis.

When using the “user correction factors”, the measuring frequency needs to be sent to the probe when reading the field strength in order to apply the applicable correction factor.

## EMSense 10 Typical Performance Data

---

### Typical Probe Isotropic Response at 400 MHz

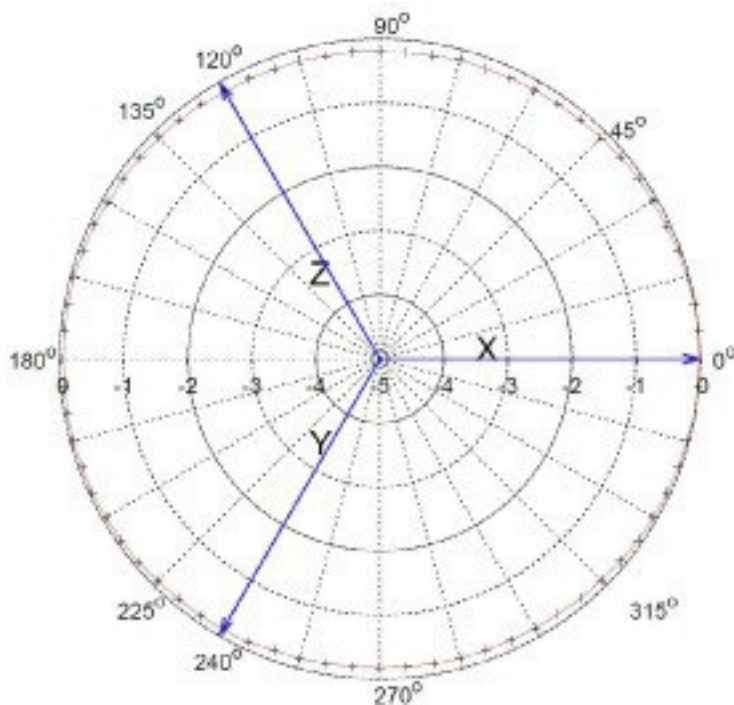



**Typical Probe Isotropic Response at 1000 MHz**

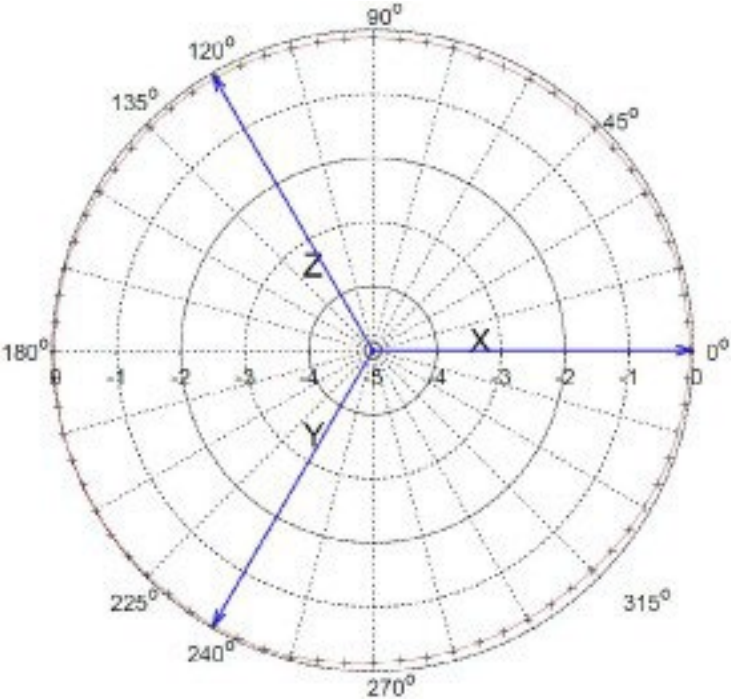

**Typical Probe Isotropic Response at 3000 MHz**

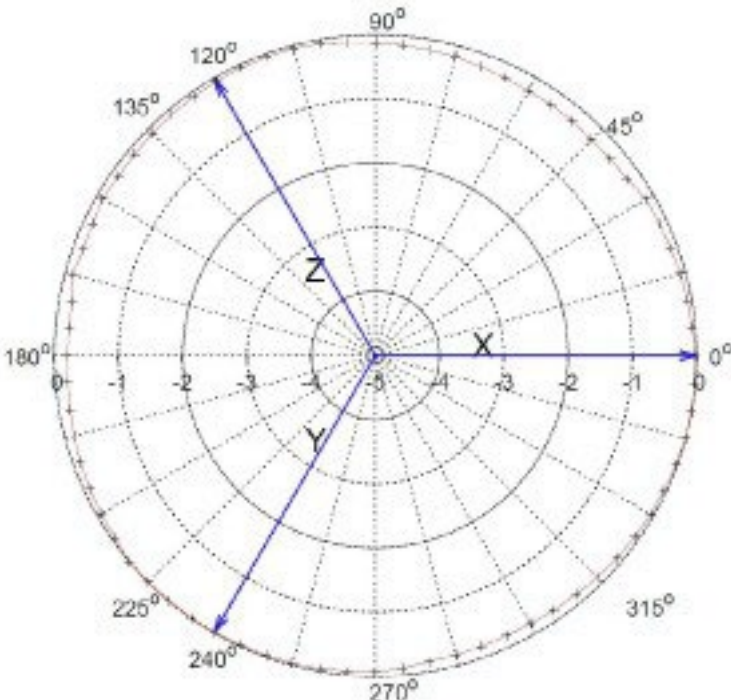

## Typical Probe Isotropic Response at 6000 MHz

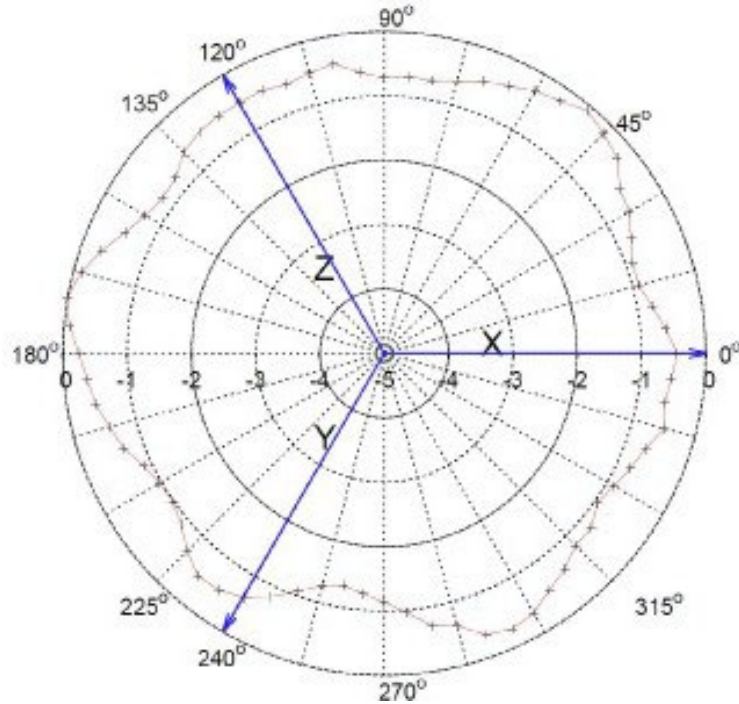

### Remote Control

---



To use the EMSense 10/40 remote commands, read the [manual document 399342 EMCenter](#) for examples and a full command list.

## Software Configuration for EMCenter 1-slot

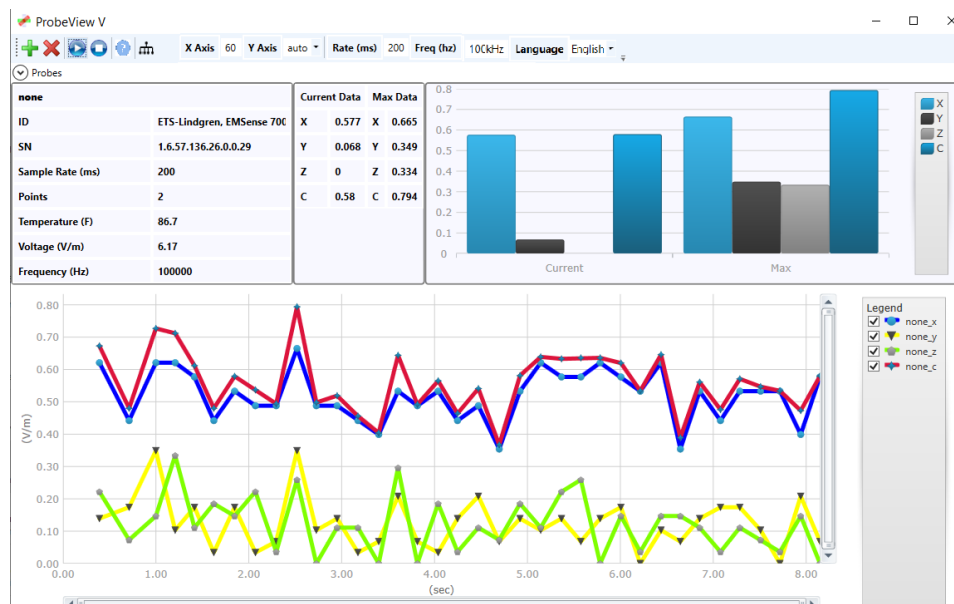

To control the EMSense 10 from a computer, custom-made software can be used. **ProbeView V** is a simple software package available for download at [ETS-Lindgren.com](http://ETS-Lindgren.com) that provides real-time display, logging, and analysis of probe data as a support tool for EMF measurements. The software displays a variety of test information, both numerically and graphically.

### ProbeView V Required Components

- Microsoft Windows PC with one available Serial/COM or USB port
- EMCenter 1
- EMSense 10 Electric Field Probe
- EMSense 10 interface card
- Fiber Cable
- ProbeView V.msi

## ProbeView V Setup

If you already have a version of ProbeView on your PC, uninstall it before installing ProbeView V.

1. Download and install ProbeView V.msi.
2. Accept all the license agreements and select FINISH.
3. Connect the fiber optic cable from the fiber optic ports on the probe to the EMSense 10 in the EMCenter and then connect the EMCenter to the PC.
4. Turn on the EMCenter and then the probe.
5. Start ProbeView V.
6. Check probe connection with NI\_Max.
7. Add a probe configuration to ProbeView V using NI\_Max settings.

## Maintenance

---



**CAUTION:** Before performing any maintenance, follow the safety information in the ETS-Lindgren *Product Information Bulletin* included with your shipment.



**WARNING:** Maintenance of the EMCenter is limited to external components such as cables or connectors. If you have any questions concerning maintenance, contact ETS-Lindgren Customer Service.



If you have any questions concerning maintenance, contact ETS-Lindgren Customer Service.

## Fiber Optic Maintenance

---

The fiber optic cables in the EMSense 10/40 are a crucial part of the system. Fiber optic connectors and cables can be damaged from airborne particles, humidity and moisture, oils from the human body, and debris from the connectors they plug into. Always handle connectors and cables with care, using the following guidelines.



**CAUTION: Before performing any maintenance, disconnect fiber optic cables from the unit and turn off power.**

- **When disconnecting fiber optic cables, apply the included dust caps to the ends to maintain their integrity.**
- **Before connecting fiber optic cables, clean the connector tips and in-line connectors.**
- **Before attaching in-line connectors, clean them with moisture-free compressed air.**
- **Failure to perform these tasks may result in damage to the fiber optic connectors or cables.**

## Handling Guidelines

---

- Always place the plastic end-caps on the fiber connectors when they are not in use. Only use the supplied end caps.
- Never touch the tip of the fiber connector (core surface). If the tip of the connector is touched, use the supplied alcohol wipes to clean it before usage!
- Never drop the fiber connectors, as this may damage the core surface.
- Never bend the fibers (exceed the minimum bend radius 2 in or 5 cm), as this will break the fiber core.
- Never pull the fiber connector out of a coupling by its orange jacket, always use the connector.
- Fasten the connectors by hand only, never use tools.
- Do not stand on or crush the fibers.
- Do not apply mechanical stress (pull) to the fibers.
- Switch off the system before detaching the fibers.

## Fiber Conditions

---

Use the examples and instructions in the following figure as a guideline for further fiber maintenance. If you have doubts about the condition of the fiber optic cables, please contact your local reseller or ETS-Lindgren for assistance and/or advice.

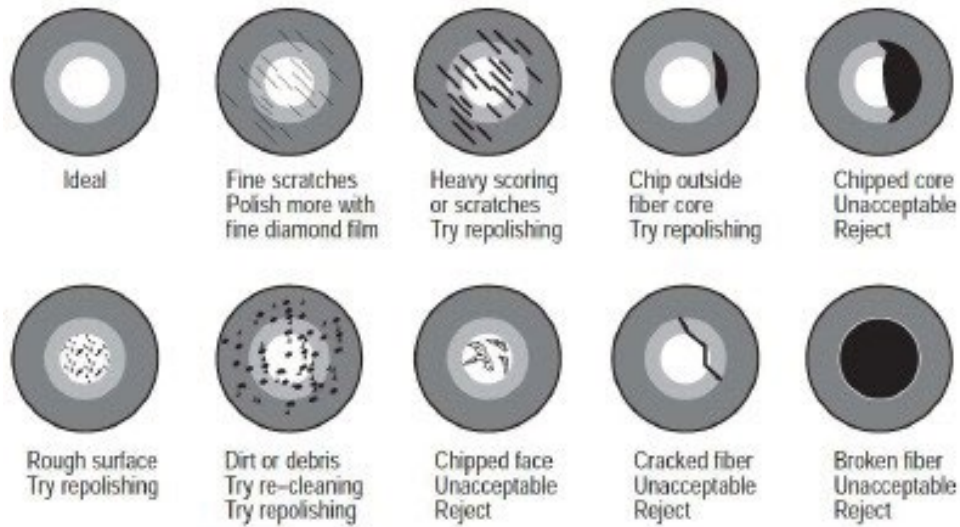

## Service Procedures

---

### Contacting ETS-Lindgren

---



**Note:** Please see [www.ets-lindgren.com](http://www.ets-lindgren.com) for a list of ETS-Lindgren offices, including phone and email contact information.

### Replacement and Optional Parts

---



**Note:** ETS-Lindgren may substitute a similar part or new part number with the same functionality for another part/part number. Contact ETS-Lindgren for questions about part numbers and ordering parts.

Part Number	Part Description
7007-200	EMSense 10 Plug-in Card
7007-201	EMSense 10 E-field sensor (with fixed fiber cables)

## **Sending a Component for Service**

---

For the steps to return a system or system component to ETS-Lindgren for service, see the *Product Information Bulletin* included with your shipment.

## **Calibration Services and Annual Calibration**

---

See the *Product Information Bulletin* included with your shipment for information on ETS-Lindgren calibration services.

## **Upgrade Policies**

---

Periodically, field probes are upgraded to enhance functionality. Contact ETS-Lindgren Customer Service for the upgrade status of your field probe.



## Specifications

---

### EMSense 10 Probe Specifications

---

#### Electrical (EMSense 10)

---

<b>Field measurement range</b>	1 to 750 V/m
<b>Max input level before damage</b>	1000 V/m
<b>Frequency range</b>	10 kHz to 10 GHz (usable to 12 GHz)
<b>Frequency response 10 kHz to 10 GHz (with internal correction)</b>	$\pm 1$ dB
<b>Resolution</b>	0.01 V/m
<b>Linearity</b>	$\pm 0.5$ dB $\pm 0.5$ V/m, 1-500 V/m
<b>Isotropy</b>	< $\pm 0.3$ dB up to 1 GHz < $\pm 0.5$ dB up to 3 GHz < $\pm 1$ dB up to 6 GHz < $\pm 2$ dB up to 10 GHz
<b>Number of antennas</b>	6 (2 per axis)
<b>Measuring speed</b>	Max 100 measurements/sec
<b>Temperature error (23°C <math>\pm</math> 5°C)</b>	0.1 dB/°C (after zeroing)

## Physical (EMSense 10)

---

<b>Shape of housing</b>	Spherical
<b>Diameter of housing</b>	0.98 in (2.5 cm)
<b>Weight</b>	1.77 oz (65 g)
<b>Electrical dimensions</b>	6.9 in <sup>3</sup> (117 cm <sup>3</sup> )
<b>Temperature range (operating)</b>	32° F to 104° F (0° C to 40° C)
<b>Relative humidity (operating)</b>	10% – 90% (non-condensing)

## Optical (EMSense 10)

---

<b>LASER power</b>	Max. 0.5 Watt output at aperture
<b>Wavelength</b>	808 nm
<b>LASER connector</b>	FC/FC
<b>Data connector</b>	ST/ST
<b>Fibers</b>	200/230 µm HCS, duplex
<b>Standard fiber length</b>	1.5 m fixed to sensor 10 m or 20 m extension with couplings (Other lengths available on request)

## Safety (EMSense 10)

---

<b>LASER product classification</b>	Class 1M according to EN 60825-1 and EN60825-2
<b>Safety measures</b>	Code (EMCenter), Remote interlock system (EMCenter), LED indications for LASER ON, Audible warning signals Redundant closed loop safety system
<b>LASER switch on time</b>	Approximately 50 ms
<b>LASER switch off time</b>	< 10 ms

## Calibration (EMSense 10)

---

<b>Factory accredited calibration</b>	Internally stored, ISO17025 calibration
---------------------------------------	---

## EMSense 40 Probe Specifications

---

### Electrical (EMSense 40)

---

<b>Field measurement range</b>	2 to 1000 V/m
<b>Max input level before damage</b>	2000 V/m
<b>Frequency range</b>	10 MHz to 40 GHz
<b>Frequency response 10 kHz to 10 GHz (with internal correction)</b>	$\pm 1.2$ dB
<b>Resolution</b>	0.001 V/m 2 - 10 V/m 0.01 V/m 10 - 100 V/m 0.1 V/m 100 – 1000 V/m
<b>Linearity</b>	$\pm 0.5$ dB $\pm 0.5$ V/m
<b>Isotropic Deviation</b>	$\pm 0.5$ dB @ 1 GHz
<b>Number of antennas</b>	3 Dipoles
<b>Measuring speed</b>	Max 100 measurements/sec
<b>Temperature error (23°C <math>\pm</math> 5°C)</b>	0.1 dB/°C (after zeroing)

### Physical (EMSense 40)

---

<b>Shape of housing</b>	Stalk probe
<b>Diameter of housing</b>	0.57 in (1.5 cm)
<b>Weight</b>	3.2 oz (91 g)
<b>Electrical dimensions</b>	6.9 in <sup>3</sup> (117 cm <sup>3</sup> )
<b>Temperature range (operating)</b>	32° F to 104° F (0° C to 40° C)
<b>Relative humidity (operating)</b>	10% – 90% (non-condensing)

### Optical (EMSense 40)

---

<b>LASER power</b>	Max. 0.5 Watt output at aperture
<b>Wavelength</b>	808 nm
<b>LASER connector</b>	FC/FC
<b>Data connector</b>	ST/ST
<b>Fibers</b>	200/230 µm HCS, duplex
<b>Standard fiber length</b>	10 m optional 20 and 30 m Maximum 100 m (Other lengths available on request)

### Safety (EMSense 40)

---

<b>LASER product classification</b>	Class 1M according to EN 60825-1 and EN60825-2
<b>Safety measures</b>	Code (EMCenter), Remote interlock system (EMCenter), LED indications for LASER ON, Audible warning signals Redundant closed loop safety system
<b>LASER switch on time</b>	Approximately 50 ms

<b>LASER switch off time</b>	< 10 ms
------------------------------	---------

### **Calibration (EMSense 40)**

---

<b>Factory accredited calibration</b>	Internally stored, ISO17025 calibration
---------------------------------------	---

## Appendix A: EC Declaration on Conformity

---

ETS-Lindgren Inc. declares these products to be in conformity with the following standards and provisions:

**Product Models:** EMSense 10/40 Electric Field Probes

**Directives:** EMC Directive 2014/30/EU  
Low Voltage Directive 2014/35/EU  
RoHS Directive: 2015/863/EU

**Emission:** EN 61326-1:2013, Class A1  
Electrical equipment for measurement, control and laboratory use.

**Immunity:** EN 61326-1:2013, Industrial level, performance criteria A  
Electrical equipment for measurement, control and laboratory use.

**Safety:** EN 61010-1:2010, Safety requirements for electrical equipment  
for measurement, control, and laboratory use.

EN60825-1:2014, Safety of laser products - Part 1: Equipment  
classification and requirements.

Technical Construction Files are available upon request.



Accelonix BV ■ Luchthavenweg 18-b ■ NL-5657 EB Eindhoven  
[www.accelonix.nl](http://www.accelonix.nl) ■ [info@accelonix.nl](mailto:info@accelonix.nl) ■ Tel.+31-40-7501650