

AC/DC/IR Hipot Tester

MODEL 19070 SERIES 19050 SERIES

Key Features

- AC/DC/IR 3 in 1 hipot tester
- AC 5kV and DC 6kV output
- 1kV insulation resistance test
- Insulation resistance measurement from 1M Ω to 50G Ω
- Ground continuity check (GC)
- Standard RS-232 interface
- Open short check(OSC) function
- GFI shutdown of the instrument when current imbalance > 0.5mA
- Flashover (ARC) detection
- Quick discharge of DUT in IR and DC test
- Pause mode
- UL and TUV approved (*see spec)
- CE mark
- Programmable ramp/fall and test time
- Programmable high/low limit
- Save/Recall program test function
- Remote control and interface support



AC/DC/IR HIPOT TESTER MODEL 19070 & 19050 SERIES

Complete Dielectric Testing Solution

The 19050 series electrical safety testers are advanced digital hipot testers with load and line regulation to ensure measurement integrity. Multi-step capability allows users to perform multiple tests in sequence, such as AC hipot followed by IR.

The Chroma Hipot Tester 19050 series provides 3 models to choose from. The 19052 includes AC/DC/IR Hipot testing and insulation resistance (IR) measurements. The 19053 provides 8 scan channels for IR measurement, and the 19054 provides 4 scan channels for IR measurement in a single compact unit.

The Chroma Hipot Tester 19070 series provides 2 models to choose from. The 19071 is for AC Hipot testing. The 19073 combines both AC and DC Hipot with insulation resistance (IR) measurements into a single compact unit.

Open Short Check (OSC)

The OSC function is used to check whether the connection is an open circuit between the instrument and the DUT or if there is a breakdown inside the DUT before testing for electrical safety.

Flashover (ARC) Detection

The 19070 and 19050 series are sensitive enough to monitor for current spikes even if they do not exceed the maximum trip current level.

Ground Continuity Check (GC)

All of the 19050 series testers have a ground continuity check feature to determine if the resistance between the ground blade of the power cord and any exposed metal on the product is less than 1 Ω .

Ground Fault Interrupt (GFI)

GFI is required by the National Electrical Code in wet locations. Such devices automatically interrupt power when a ground current > 0.5mA exists for more than a few milli-seconds to protect users.

Quick Discharge

In DC hipot and IR tests, the device under test is discharged back through the HV transformer. This technique results in a rapid and safe discharge.



Chroma



MAIN FUNCTIONS

FLASHOVER DETECTION (ARC)

Fast transients in Voltage or Current occurring while Hi-Pot testing are called Electrical Flashover. Normally, with AC line frequency (50Hz/60Hz) or DC Hi-Pot testing, the leakage current is the same 50Hz/60Hz or DC (charge current excepted). As shown in Figure 1, leakage current varies smoothly.

In contrast, when electrical discharge occurs due to poor insulation materials, electrode gaps, surface clearances, etc., fast transients in leakage current become apparent, as shown in Figure 2. This is a phenomenon of poor withstanding. Most of Electrical Safety regulations mention a necessity for a Withstand Strength Test. Nevertheless, general Hi-Pot testers only detect the RMS value of leakage current, without the capability to detect Flashover. Therefore, a Hi-Pot tester equipped with the FLASHOVER detection function is necessary.

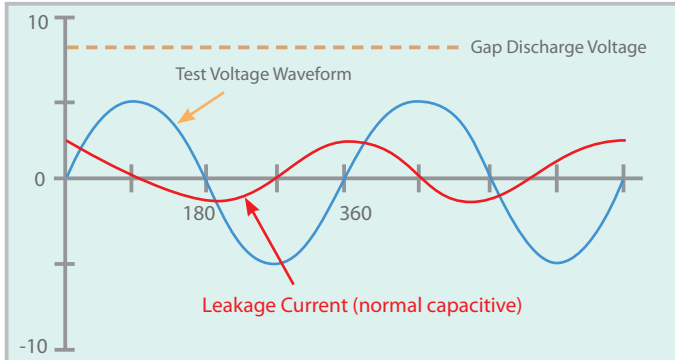

Figure 1 : Normal Leakage Current Waveform

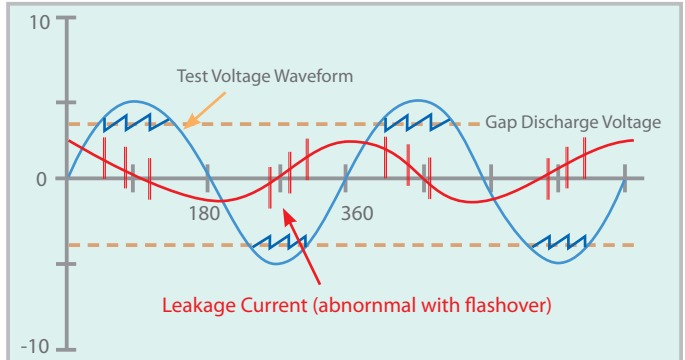
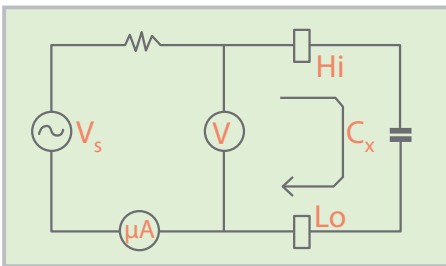

Figure 2 : Leakage Current Waveform when flashover occurred

OPEN/SHORT CHECK (OSC)

The O.S.C function is used to check whether the connection is open or is a short circuit between the instrument and the DUT (equipment under test) before the Electrical Safety Test begins. If the connection between the instrument and DUT is bad, like a bad lead or relay oxidation, the test will also PASS. In some cases, the DUT is short before testing. Testing continually leads to instrument failure due to it suffering the high load current. Therefore, we check the open and short circuit to ensure the test effectively and protect the instruments.

Normally, DUT have capacitive loads (C_x) from tens to thousands of pF. If the connection is open, a capacitance will appear and total capacitive load will be lower than that of normal conditions. If the DUT is shorting, total capacitive load is higher than that of normal conditions. Therefore, we can measure the value of the capacitive load to check whether the contact is good or not.



Normal Condition

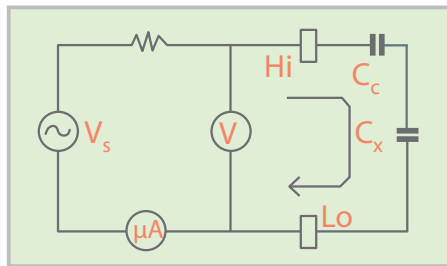

If Circuit Opened :
 $C = C_c * C_x / (C_c + C_x) \ll C_x$

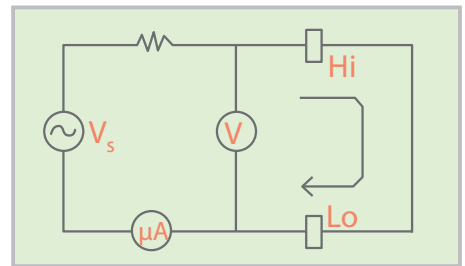

If Circuit Shorted :
 $C \gg C_x$

GROUND FAULT INTERRUPT (GFI)

Requirements for test environments indicate that test equipment must be equipped with an auto interrupt device, so Chroma developed a built in Ground Fault Interrupt (GFI) function. When the current meters A1 and A2 detect difference ($i_2 - i_1 = i_H$) between the values i_1 and the actual i_2 test current over high, the instrument can cut the power transiently in order to protect a human body safely. It is not only compliant with the safety standard but also provides more safeguards for test personnel.

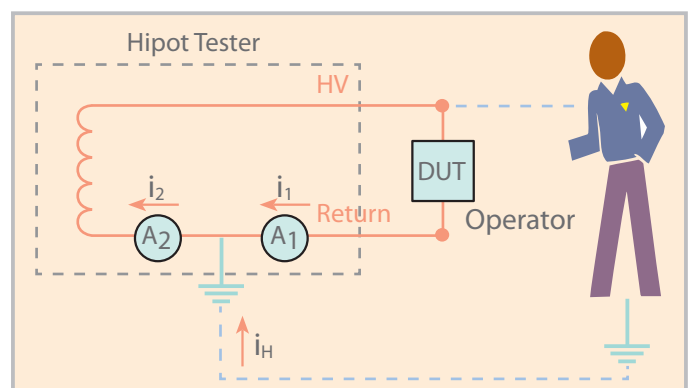

PANEL DESCRIPTION

19073

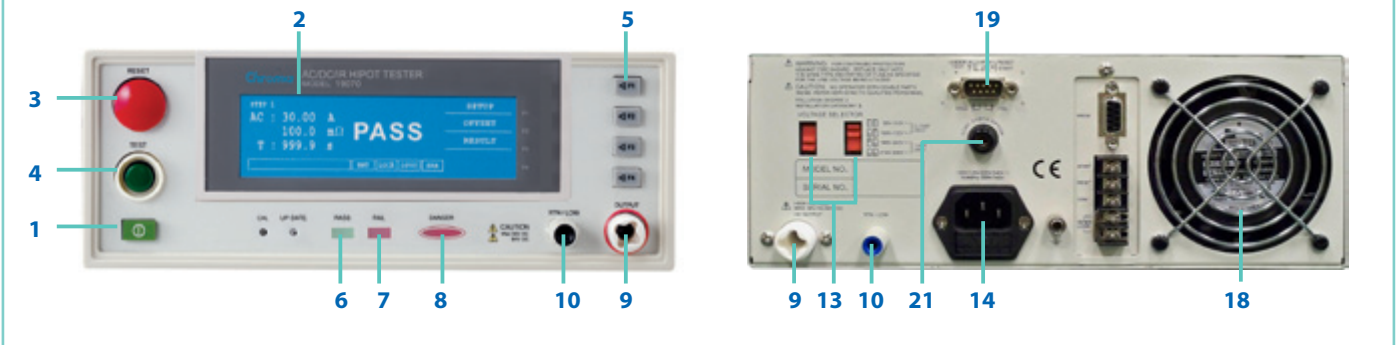

19053

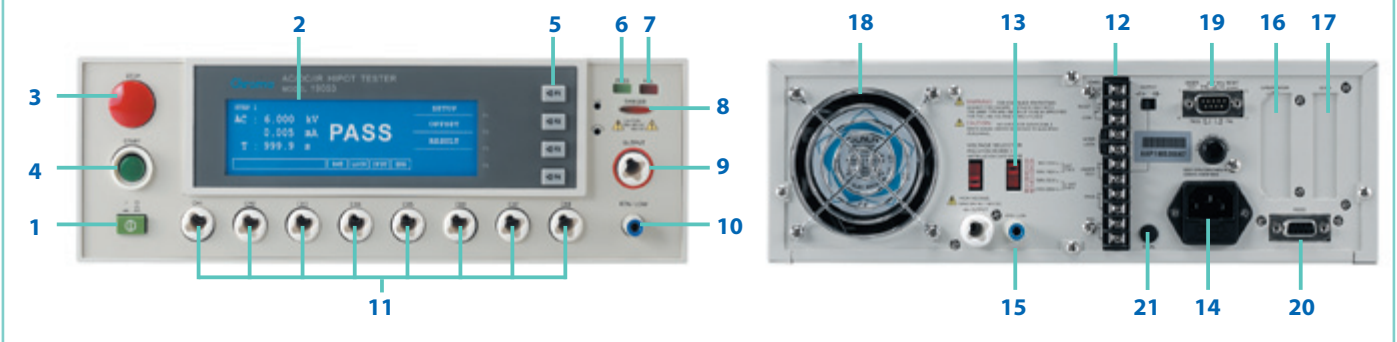

- | | | |
|--------------------------|--|-------------------------------------|
| 1. LINE Switch | 9. HV Output | 16. GPIB/Printer Interface (Option) |
| 2. Window Display | 10. RTN/LOW | 17. Scan Interface (Option) |
| 3. Stop Button | 11. 8 channels HV Output
(19053 only) | 18. Fan |
| 4. Start Button | 12. Remote I/O | 19. Remote Interface |
| 5. Function Keys (F1~F4) | 13. LINE Voltage Selector | 20. RS-232 Interface |
| 6. Pass Indicator | 14. Power Cord Receptacle | 21. Continuity Test O/P |
| 7. Fail Indicator | 15. RTN/LOW | |
| 8. Test Indicator | | |

APPLICATION

- Production test of appliances, instruments and information technology equipment in accordance with UL, IEC, TUV and other standards such as EN 60335, EN 60950, EN 61010, CSA C22.2 No.1010.1, UL 3111 and UL 1950
- Transformer electrical safety test
- Various electronic components tests

ORDERING INFORMATION

- | | |
|---|--|
| 19071 : AC Hipot Tester | 19052 : Hipot Tester (AC/DC/IR) |
| 19073 : AC/DC/IR Hipot Tester | 19053 : Hipot Tester (AC/DC/IR/ 8CH SCAN) |
| A190701 : Remote Control Box | 19054 : Hipot Tester (AC/DC/IR/ 4CH SCAN) |
| A190702 : 40kV Test Probe | A190344 : HV Gun (SP02) |
| A190704 : Start Switch | A190508 : GPIB Interface |
| A190706 : 19" Rack Mount Kit | A190512 : Auto Control TR. Scan Box |
| A190708 : ARC Verification Fixture | A190517 : 19" Rack Mount Kit |

SPECIFICATIONS

Model	19071	19073	19052	19053	19054
Mode	ACV	ACV / DCV / IR	ACV / DCV / IR	ACV / DCV / IR / SCAN	
Scanner Unit	-	-	-	8 ports,±phase	4 ports,±phase
Withstanding Voltage Test					
Output Voltage	AC : 0.05 ~ 5kV, DC : 0.05 ~ 6kV				
Load Regulation	$\leq (1\%+5V)$				
Voltage Resolution	2V				
Voltage Accuracy	1% of setting + 5 count				
Cutoff Current	AC : 0.1~20mA, DC : 0.01 ~ 5mA		AC : 0.1 ~ 30mA, DC : 0.01 ~ 10mA		
Current Resolution	AC : 1 μ A, DC : 0.1 μ A				
Current Accuracy	$\pm(1.5\%$ of reading + 5 counts)		$\pm(1\%$ of reading + 5 counts)		
Output Frequency	50Hz / 60Hz				
Test Time	0.3 ~ 999 sec., continue				
Ramp Time	0.1 ~ 999 sec., off				
Fall Time	0.1 ~ 999 sec., off				
Dwell Time	0.1 ~ 999 sec., off				
Waveform	Sine wave				
Insulation Resistance					
Output Voltage	-	DC : 0.05 ~ 1kV			
Voltage Resolution	-	2V			
Voltage Accuracy	-	$\pm(1\%$ of reading + 5 counts)			
IR Range	-	1M Ω ~50G Ω	1M Ω ~10G Ω		
Resistance Accuracy	$\geq 500V$	1.00M Ω ~ 25.00M Ω	-	$\pm(4\%$ of reading + 5 counts)	$\pm(5\%$ of reading + 2% of full scale)
		22.0 M Ω ~250.0M Ω	-		
		0.220G Ω ~1.000G Ω	-	$\pm(7\%$ of reading + 5 counts)	$\pm(10\%$ of reading + 2% of full scale)
		1.000G Ω ~2.500 G Ω	-		
	$\leq 500V$	2.20G Ω ~10.00G Ω	-	$\pm(12\%$ of reading + 5 counts)	$\pm(15\%$ of reading + 5% of full scale)
		10.00G Ω ~50.00G Ω	-		
		0.10 M Ω ~25.00M Ω	-	$\pm(7\%$ of reading + 5 counts)	$\pm(10\%$ of reading + 2% of full scale)
		22.0M Ω ~250.0M Ω	-		
0.220 G Ω ~1.000G Ω	-	$\pm(10\%$ of reading + 5% of full scale)			
Flashover (ARC) Detection					
Setting Mode	Programmable setting				
Detection Current	AC : 1mA ~ 20mA, DC : 1mA ~ 5mA		AC : 1mA ~ 15mA, DC : 1mA ~ 10mA		
Secure Protection Function					
Fast Output Cut-off	0.4ms after NG happen				
Ground Fault Interrupt	0.5mA \pm 0.25mA AC, ON/OFF				
Panel Operation Lock	Present password				
Continuity Check	1~5 Ω \pm 0.2 Ω , ON/OFF		1 Ω \pm 0.2 Ω , ON/OFF		
GO/NG Judgment Window					
Indication, Alarm	GO : Short sound, Green LED ; NG : Long sound, Red LED				
Data Hold	Least tests data memories				
Memory Storage	10 steps or 60 groups for total 60 memory		99 steps or 99 groups for total 500 memory		
Remote & Interface					
Remote control	Input : Start, Stop, Interlock (at 11 pin terminal block only) ; Output : Under test, Pass, Fail				
Communication Interface	RS485 (Option)		RS232 (Standard), GPIB (Option)		
General					
Operation Environment	Temperature : 0°C~40°C ; Humidity : 15% to 95% R.H@ \leq 40°C				
Power Requirements	100V/120V/220V/240V (AC \pm 10%), 50/60Hz				
Power Consumption	300W		500W		
Dimension (W x H x D)	270 x 105 x 350 mm		320 x 105 x 400 mm		
Weight	Approx.12 KG		Approx.15 kg		
Certification	UL, TUV, CE		UL, TUV, CE	CE	UL, TUV, CE

*All specifications are subject to change without notice.

HEADQUARTERS
CHROMA ATE INC.
 66 Huaya 1st Road,
 Guishan, Taoyuan
 33383, Taiwan
 T +886-3-327-9999
 F +886-3-327-8898
 www.chromaate.com
 info@chromaate.com

U.S.A.
CHROMA SYSTEMS
SOLUTIONS, INC.
 19772 Pauling, Foothill Ranch,
 CA 92610
 T +1-949-600-6400
 F +1-949-600-6401
 www.chromausa.com
 sales@chromausa.com

EUROPE
CHROMA ATE EUROPE B.V.
 Morsestraat 32, 6716 AH Ede,
 The Netherlands
 T +31-318-648282
 F +31-318-648288
 www.chromaeu.com
 sales@chromaeu.com

JAPAN
CHROMA JAPAN CORP.
 472 Nippa-cho, Kouhoku-ku,
 Yokohama-shi, Kanagawa,
 223-0057 Japan
 T +81-45-542-1118
 F +81-45-542-1080
 www.chroma.co.jp
 info@chroma.co.jp

CHINA
CHROMA ELECTRONICS
(SHENZHEN) CO., LTD.
 8F, No.4, Nanyou Tian An
 Industrial Estate, Shenzhen,
 China PC: 518052
 T +86-755-2664-4598
 F +86-755-2641-9620

Worldwide Distribution and
 Service Network



19070+19050-E-201507-500